

TFT COLOR DISPLAY WIFI WEATHER STATION

Operation Manual

Model: HP2552

Thank you for purchasing this TFT Color Display Weather Station! This device provides accurate weather readings and is Wi-Fi capable to stream data from the weather station to Internet based weather services.

This manual will guide you, step-by-step, through setting up your weather station and console, and understanding the operation of your weather station. Use this manual to become familiar with your professional weather station and save it for future reference.



Note: The stainless steel pole for the wireless anemometer is not included.

1 Table of Contents

1 TABLE OF CONTENTS	2
2 UNPACKING.....	5
3 OVERVIEW.....	7
3.1 DISPLAY CONSOLE.....	7
3.2 INDOOR SENSOR	8
3.3 OUTDOOR TEMPERATURE AND HUMIDITY SENSOR.....	9
3.4 FEATURES.....	9
4 SET UP GUIDE	11
4.1 SITE SURVEY.....	11
4.2 WIRELESS ANEMOMETER SENSOR ASSEMBLY	12
4.2.2 <i>Install U-bolts and metal plate</i>	13
4.2.3 <i>Install wind vane</i>	14
4.2.4 <i>Install wind speed cups</i>	15
4.2.5 <i>Install Batteries in sensor package</i>	16
4.2.6 <i>Mount assembled wireless anemometer sensor</i>	16
4.2.7 <i>Reset Button and Transmitter LED</i>	18
4.3 RAIN GAUGE SENSOR SET UP.....	19
4.3.1 <i>Install Rain Collector Top</i>	19
4.3.2 <i>Install Batteries in rain gauge sensor</i>	20
4.3.3 <i>Mounting</i>	21
4.4 INDOOR SENSOR SET UP.....	23
4.4.1 <i>Sensor Placement</i>	23
4.5 OUTDOOR TEMPERATURE AND HUMIDITY SENSOR OPERATION.....	24
4.6 BEST PRACTICES FOR WIRELESS COMMUNICATION	24
4.7 CONSOLE DISPLAY.....	26
4.7.1 <i>Initial Display Console Set Up</i>	27
4.7.2 <i>Key functions</i>	27
5 OPERATING THE CONSOLE	29

5.1 NORMAL MODE	29
5.1.1 Outdoor or “Feels Like”	29
5.1.2 Rain data	30
5.1.3 Graphed data	30
5.2 SETTING MODE	31
5.2.1 Backlight	31
5.2.2 Data Units	32
5.2.3 Coefficients	32
5.2.4 Barometer	33
5.2.5 Rainfall	33
5.2.6 Graph Time	33
5.2.7 Time Format	33
5.2.8 Date Format	34
5.2.9 Date and Time	34
5.2.10 Sensor Type	34
5.3 CALIBRATION MODE	34
5.3.1 Calibration of barometric pressure settings	35
5.4 ALARM MODE	39
5.5 TEMPERATURE MAX/MIN MODE	40
5.6 OTHER MAX/MIN MODE	40
5.7 RAINFALL	41
5.8 FACTORY MODE	41
6 OTHER CONSOLE FUNCTIONS	43
6.1 HISTORICAL DATA STORAGE	43
6.2 SENSOR IDENTIFICATION	43
6.3 BEAUFORT WIND FORCE SCALE	44
7 PUBLISHING TO INTERNET WEATHER SERVICES	45
7.1 WI-FI CONNECTION FOR THE WEATHER STATION CONSOLE	45
7.1.1 Download mobile application	46
7.1.2 Register a Personal Weather Station (PWS) with wunderground.com... ..	46
7.1.3 Activate setup application	47
7.1.4 Configure Device – Connect your console with WIFI	48

7.2 REGISTERING WITH AND USING WUNDERGROUND.COM.....	53
7.2.1 Viewing data on wunderground.com.....	55
8 PC SOFTWARE OPERATION	59
8.1 INSTALLATION AND CONFIGURATION.....	59
8.1.1 Connect the display console to the PC.....	59
8.2 SETUP FUNCTIONS.....	60
8.2.1 Basic Settings.....	61
8.2.2 Alarm Settings.....	61
8.2.3 Calibration Settings.....	62
8.2.4 Rain Totals.....	63
8.3 RECORD AND RECORDING FUNCTIONS	64
8.3.1 Max/Min.....	65
8.3.2 SDCard File.....	66
9 MAINTENANCE.....	68
10 TROUBLESHOOTING GUIDE	70
11 GLOSSARY OF COMMON TERMS	74
12 SPECIFICATIONS	77
13 WARRANTY INFORMATION.....	79

2 Unpacking

Open your weather station box and inspect that the contents are intact (nothing broken) and complete (nothing missing). Inside you should find the following:

QT	Item Description
1	Display Console
1	Wireless Anemometer with built-in: Wind Speed Sensor/ Wind Direction Sensor, Light and UV sensor, Solar panel
1	Wind speed cups (to be attached to anemometer sensor body)
1	Wind vane (to be attached to anemometer sensor body)
1	USB Cable (for console to PC connectivity)
1	Indoor sensor unit(temperature, humidity and pressure)
1	Outdoor temperature and humidity sensor unit
1	Rain gauge sensor unit
2 Set	U-Bolts for mounting on a pole(2pcs/set)
2 Set	Threaded nuts for U-Bolts (M5 size)(4pcs/set)
2 Set	Metal mounting plate to be used with U-Bolts(1pcs/set)
1	Stainless steel tube (for mounting the rain gauge sensor)
1	Wrench for M5 bolts
1	AC adapter
1	User manual (this manual)

Table 1: Package content

If components are missing from the package, or broken, please contact customer service to resolve the issue.

Note: The console can store historical data on a memory card. This memory card is **not included**. If you want to use one you will need a microSD memory card. There is no required size for this card. A 1GB card will store more than 10 years' worth of data, so you do not need a very large capacity card. There is also no requirement on the speed class of this card as data writing happens infrequently and is not speed critical.

Note: Batteries for the wireless anemometer and the rain gauge sensor are all **not included**. You will need 1 AA size battery, alkaline or Lithium battery (Lithium recommended for colder climates) for each unit.

Note: The console operates using an AC adapter. The included adapter is a switching-type adapter and can generate a small amount of electrical interference with the RF reception in the console, when placed too close to the console. Please keep the console display at least 2 ft. or 0.5 m away from the power adapter to ensure best RF reception from the outdoor sensor package.

Note: There are two sets of U-bolts in the box, one is for the wireless anemometer sensor and the other one is for the rain gauge sensor. There's a short stainless steel tube included for the rain gauge sensor installation.

3 Overview

3.1 Display console

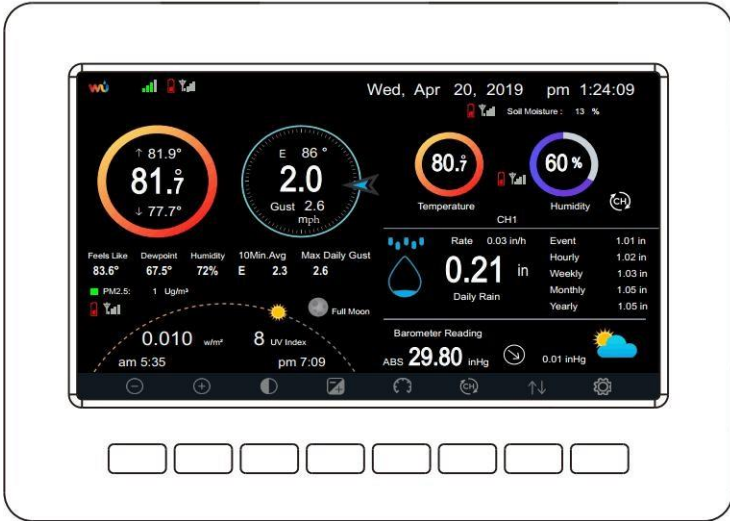

Figure 1: Display console screen

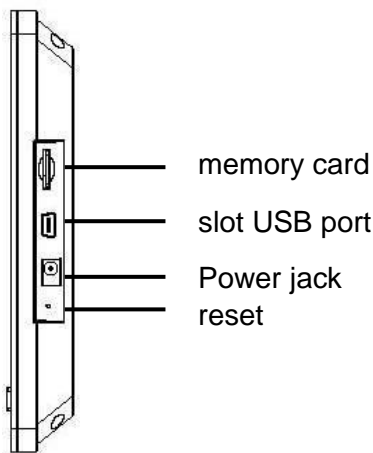

Figure 2: Display console side views

3.2 Indoor sensor:

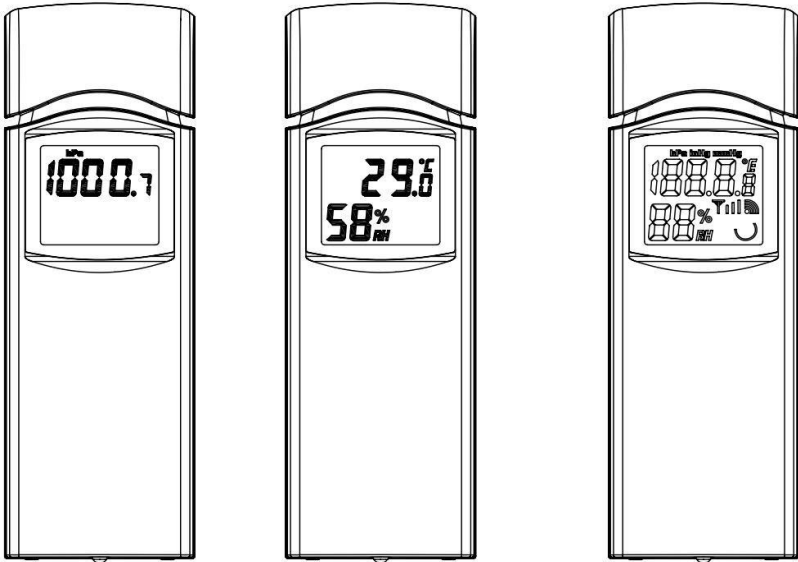

Figure 3: Indoor sensor 3 display variations

The indoor sensor will display indoor temperature, humidity and barometric pressure alternately. The sensor will use US or metric units, as appropriate for the locale where the unit was sold.

3.3 Outdoor temperature and humidity sensor:

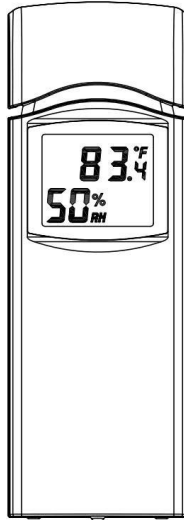

Figure 4: Outdoor temperature and humidity sensor display

3.4 Features

- 4.3" TFT full color display
- Time and date
- Indoor/Outdoor temperature and humidity
- Wind speed, gust speed, and wind direction (red arrow icon for the current wind direction and blue dot icon for the previous wind direction on the compass)
- Absolute and Relative barometric pressure
- Rainfall rate and totals for day, week, month, and year
- Calculated wind chill, dew point and heat index display
- Solar light intensity and UV index
- Selectable display units for each sensor: C or F (temperature); mph, km/h, m/s, knots or Beaufort (wind speed); inHg, hPa or mmHg (pressure); in or mm (rainfall); lux, fc or w/m^2 (solar lighting)

- Barometric history graph (12, 24, 48, or 72 hr.)
- Maximum and minimum values for sensor with time stamp
- High/low alarm options for sensors
- Historical data preserved during power outage on optional SD card
- PC software (requires USB connection)
- Supported weather services for uploading: wunderground.com, Weathercloud, and WOW
- Supports up to 8 optional WH31 multi-channel temperature and humidity sensor(sold separately).
- Supports to work with the optional WH41 PM2.5 air quality sensor and WH51 soil moisture sensor(all not included).

Note: the optional WH31, WH41 and WH51 can all be found in our amazon store. Make sure to select the units with same RF frequency.

4 Set up Guide

To complete assembly you will need a Philips screwdriver (size PH0) and a wrench (size M5; included in package).

Note: We suggest you assemble all components of the weather station, including console in one location so you can easily test functionality. After testing, place the outdoor sensors in the desired location. Note, however, that movement during assembly, and movement after assembly can cause the rain sensor to “falsely” register rain. It is therefore best if you do not connect the console to any Internet services until you have reset these false readings using the console. The errant values may be hard to remove from Internet services if you do not reset first.

Attention:

- Follow suggested order for battery installation (outdoor sensor first, console second)
- Ensure batteries are installed with correct polarity (+/-)
- Do not mix old and new batteries
- Do not use rechargeable batteries
- If outdoor temperature may go below 32F or 0C for prolonged periods, Lithium based batteries are suggested over alkaline type batteries for the outdoor sensor array

4.1 Site Survey

Perform a site survey before installing the weather station. Consider the following:

Anemometer

- Ideally mounted at 32.8 feet (10 meters) above ground level.
- Try to make the anemometer the highest object around. 7 feet(2.76 meters) or more above the surrounding obstructions is best.

Rain Gauge

- Ideally mounted at a height of 4 to 6 feet above the ground.
- Ideally located at a horizontal distance of 4 times the height of the nearest obstruction.
- Ensure the gauge is mounted level to the ground, away from any horizontal surface that can introduce rain-splashing or surrounding snow buildup.

Reference:

<https://www.weather.gov/media/epz/mesonet/CWOP-Siting.pdf>

4.2 Wireless Anemometer Sensor Assembly

See Figure 6 to locate and understand all the parts of the wireless anemometer with UV & light sensors package once fully assembled.

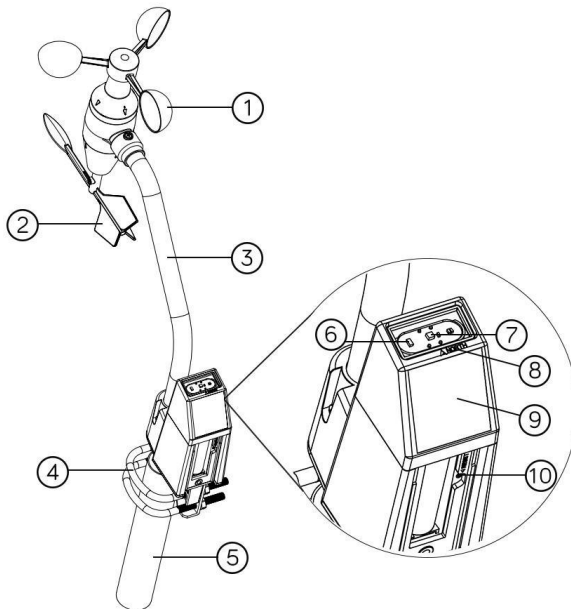

Figure 6: Sensor assembly components

1 Wind speed cups	6 LED (red) to indicate data transmission
2 Wind vane	7 Light sensor and UV sensor
3 Connection tube	8 NORTH arrow
4 U-Bolts	9 Solar panel
5 Mounting Pole(not included)	10 Reset button

Table 2: Sensor assembly detailed items

4.2.2 Install U-bolts and metal plate

Installation of the U-bolts, which are in turn used to mount the sensor package on a pole, requires installation of an included metal plate to receive the U-bolt ends. The metal plate, visible in Figure 7, has four holes through which the ends of the two U-Bolts will fit. The plate itself is inserted in a groove on the right bottom of the unit. Note that one side of the plate has a straight edge (which goes into the groove), the other side is bent at a 90-degree angle and has a curved profile (which will end up “hugging” the mounting pole). Once the metal plate is inserted, remove nuts from the U-Bolts and insert both U-bolts through the respective holes of the metal plate as shown in Figure 7.

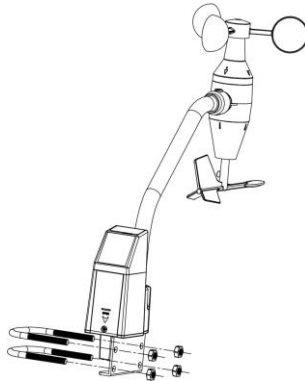

Figure 7: U-Bolt installation

Loosely screw on the nuts on the ends of the U-bolts. You will tighten these later during final mounting. Final assembly is shown in Figure 8.

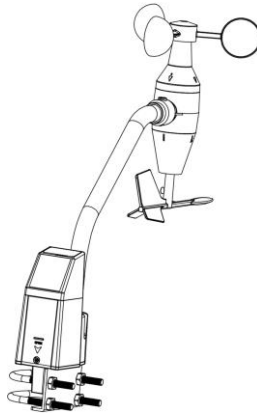

Figure 8: U-Bolts and nuts installed

The plate and U-Bolts are not yet needed at this stage but doing this now may help avoid damaging wind vane and wind speed cups later on. Handling of the sensor package with wind vane and speed cups installed to install these bolts is more difficult and more likely to lead to damage.

4.2.3 Install wind vane

Push the wind vane onto the shaft on the bottom side of the sensor package, until it goes no further, as shown on the left side in Figure 9. Next, tighten the set screw, with a Philips screwdriver (size PH0), as shown on the right side, until the wind vane cannot be removed from the axle. Make sure the wind vane can rotate freely. The wind vane's movement has a small amount of friction, which is helpful in providing steady wind direction measurements.

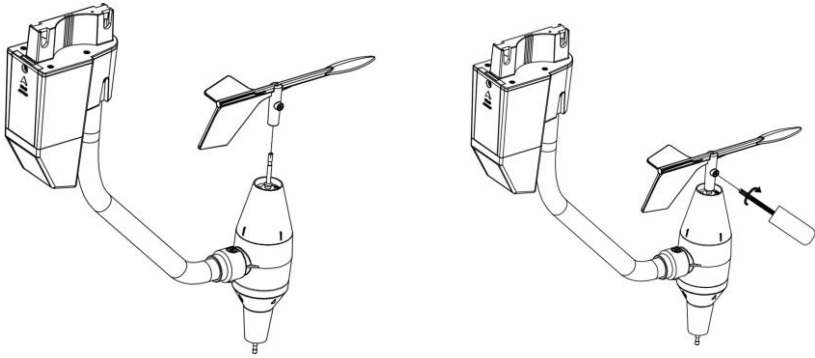

Figure 9: Wind vane installation diagram

4.2.4 Install wind speed cups

Push the wind speed cup assembly onto the shaft on the opposite side of the wind vane, as shown in Figure 10 on the top side. Tighten the set screw, with a Philips screwdriver (size PH0), as shown on the right side. Make sure the cup assembly can rotate freely. There should be no noticeable friction when it is turning.

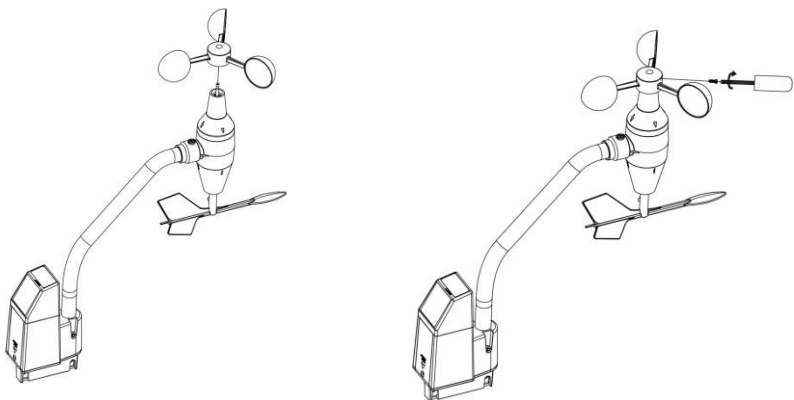

Figure 10: Wind speed cup installation diagram

4.2.5 Install Batteries in sensor package

Open the battery compartment with a screwdriver and insert 1 AA battery in the battery compartment. The LED indicator on the back of the sensor package (item 6) will turn on for 3 seconds and then flash once every 16.5 seconds indicating sensor data transmission. If you did not pay attention, you may have missed the initial indication. You can always remove the batteries and start over, but if you see the flash once every 16.5 seconds, everything should be OK.

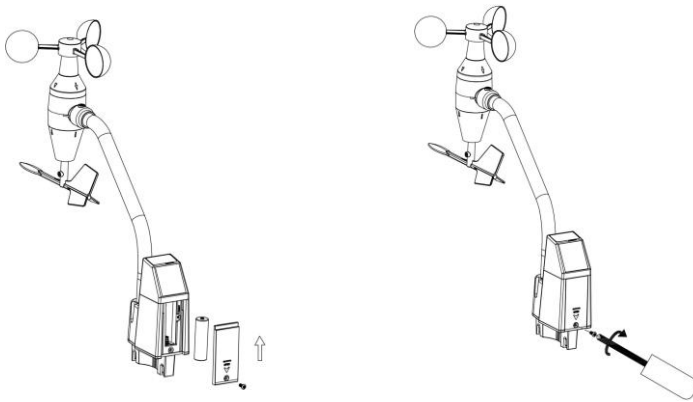

Figure 11: Battery installation diagram

Note: If LED does not light up or is on permanently, make sure the battery is inserted the correct way and inserted fully, starting over if necessary. Do not install the battery backwards as it may permanently damage the outdoor sensor.

Note: We recommend Lithium batteries for cold weather climates, but alkaline batteries are sufficient for most climates. Rechargeable batteries have lower voltages and should never be used.

4.2.6 Mount assembled wireless anemometer sensor

4.2.6.1 Before you mount

Before proceeding with the outdoor mounting detailed in this section, you may want to skip to setup instructions in section 5-7 and onwards first, while

you keep the anemometer sensor nearby (although preferably not closer than 5 ft. or 1.53m from the display console). This will make any troubleshooting and adjustments easier and avoids any distance or interference related issues from the setup.

After setup is complete and everything is working, return here for outdoor mounting. If issues show up after outdoor mounting they are almost certainly related to distance, obstacles etc.

4.2.6.2 Mounting

You can attach a pole to a permanent structure and then attach the sensor package to it (see Figure 12).

The U-Bolts will accommodate a pole diameter of 1-2 inches (pole not included).

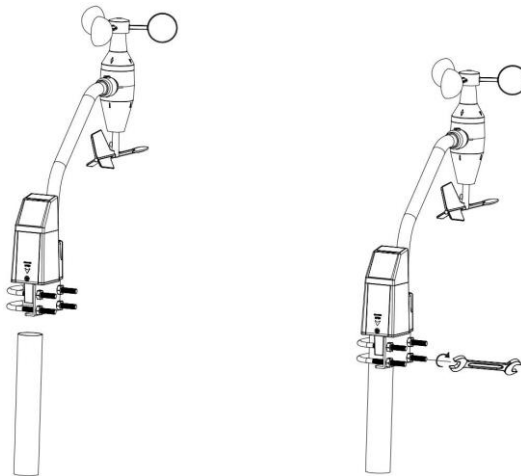

Figure 12: Sensor package mounting diagram

Make sure the mounting pole is vertical, or very close to it. Use a level if needed.

Finally, place the sensor package on top of the prepared mounting pipe. The U-Bolts should be loose enough to allow this but loosen the nuts as

necessary. Once placed, hand tightens all four nuts, taking care to do so evenly. Do not use a wrench yet!

Now you will need to align the whole package in the proper direction by rotating it on top of the mounting pipe as needed. Locate the arrow labeled “NORTH” that you will find on top of the transparent cover on the sensor package (Item 8). You must rotate the whole sensor package until this arrow points due north. To achieve proper alignment, it is helpful to use a compass (many cell phones have a compass application). Once rotated in the correct orientation, lightly tighten the bolts a little more (use a wrench) to prevent further rotation.

Note: The orientation to NORTH is necessary for two reasons. The most important one is to position the solar panel and light sensor in the most advantageous position for recording solar radiation and charging internal capacitors. Secondly it causes a zero reading for wind direction to correspond to due NORTH, as is customary.

Make sure the sensor package is installed vertically. If it is not, wind direction and speed readings may not operate correctly or accurately. Adjust the mounting pipe as necessary.

Make sure you check, and correct if necessary, the north orientation as the final installation step, and now tighten the bolts with a wrench. Do not over tighten, but make sure strong wind and/or rain cannot move the sensor package.

4.2.7 Reset Button and Transmitter LED

In the event the sensor package is not transmitting, reset the sensor.

Using a bent-open paperclip, press and hold the **RESET BUTTON** (item 10) to affect a reset: the LED turns on while the RESET button is depressed, and you can now let go. The LED should then resume as normal, flashing approximately once every 16.5 seconds.

4.3 Rain Gauge Sensor Set Up

See Figure 13 to locate and understand all the parts of the rain gauge sensor once fully assembled.

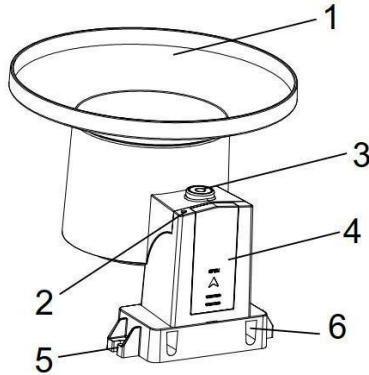

Figure 13: Sensor assembly components

1 Rain collector top	4 Battery door
2 LED Indicator	5 Screw hole
3 Bubble level	6 U-bolt install hole

Table 3: Sensor assembly detailed items

4.3.1 Install Rain Collector Top

Align the rain collector top with the rain bucket, pay attention to the lock groove position as shown on the left side in Figure 14. Next, lock the top clockwise to the lock groove position, as shown on the right side, until the top cannot be removed from the bucket.

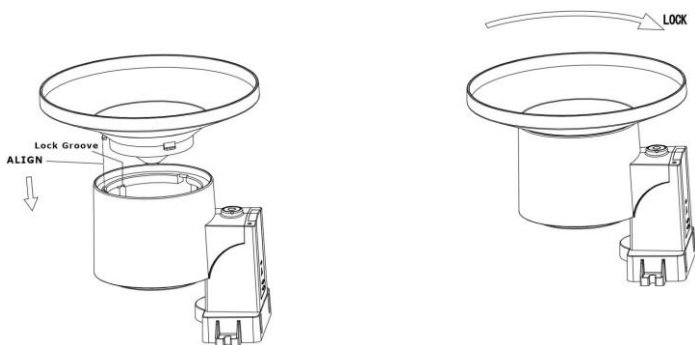

Figure 14: Rain collector top installation diagram

4.3.2 Install Batteries in rain gauge sensor

Remove the battery door on the back of the sensor by sliding it in the direction of the arrow. Insert one AA battery as described and put compartment door back and slide it in the opposite direction to lock.

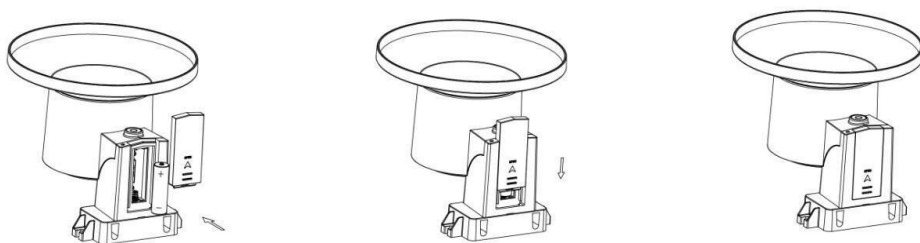

Figure 15: Rain gauge sensor battery installation diagram

The LED indicator on the top of the battery door (item 2) will turn on for 4 seconds and then flash once every 49 seconds indicating sensor data transmission. If you did not pay attention, you may have missed the initial indication. You can always remove the batteries and start over, but if you see the flash once every 49 seconds, everything should be OK.

Note: If no LED light up or is lighted permanently, make sure the battery is inserted the correct way or a proper reset is happened. Do not install the batteries backwards. You can permanently damage the outdoor sensor.

We recommend lithium batteries for cold weather climates, but alkaline batteries are sufficient for most climates. We do not recommend rechargeable batteries. They have lower voltages, do not operate well at wide temperature ranges, and do not last as long, resulting in poorer reception.

4.3.3 Mounting

Before you mount

Before proceeding with the outdoor mounting detailed in this section, you may want to skip to setup instructions in section 5-7 and onwards first, while you keep the assembled **rain gauge sensor** nearby (although preferably not closer than 5 ft. from the **display console**). This will make any troubleshooting and adjustments easier and avoids any distance or interference related issues from the setup.

After setup is complete and everything is working, return here for outdoor mounting. If issues show up after outdoor mounting they are almost certainly related to distance, obstacles etc.

Mount with U-bolts

The mounting assembly includes two U-Bolts and a bracket that tightens around a 1" to 2" diameter pole (package included a D32*H200mm stainless steel tube) using the four U-Bolt nuts.

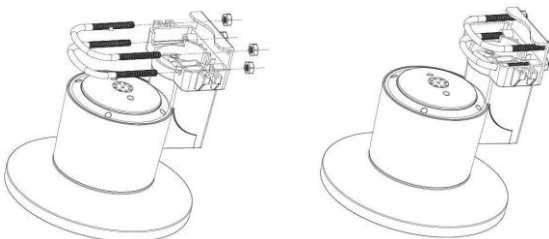

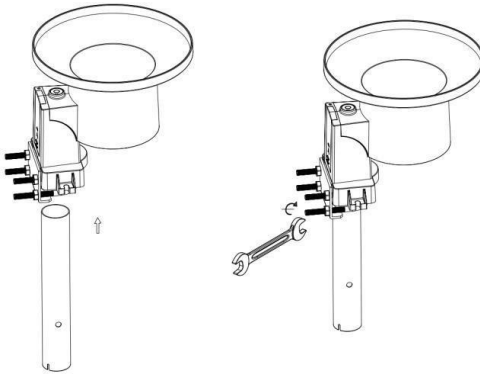

Figure 16: Rain gauge sensor mounting with u-bolts installation diagram

Note: Use the bubble level beside the rain sensor as a guide to verify that the sensor is leveled.

Mount with screws

The mounting assembly also includes two screws for installation on a flat place.

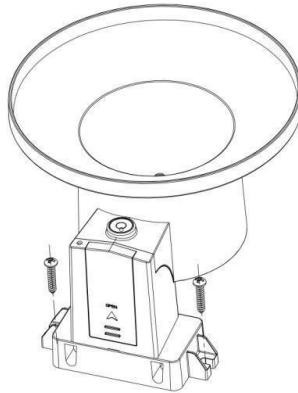

Figure 17: Rain gauge sensor mounting with screws installation diagram

Note: Use the bubble level beside the rain sensor as a guide to verify that the sensor is levelled.

4.4 Indoor Sensor Set Up

Note: To avoid permanent damage, please take note of the battery polarity before inserting the batteries. Looking at Figure 18 from left to right the left-most (or bottom) battery is to be installed with its + terminal pointing down, and the other battery with its + terminal pointing up.

Remove the battery door on the back of the sensor by sliding it in the direction of the arrow. Insert two AA batteries as described and put compartment door back and slide it in the opposite direction to lock.

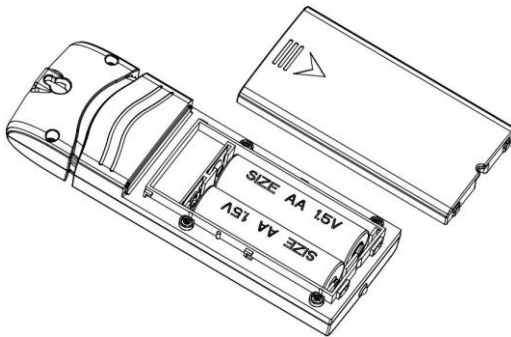

Figure 18: Indoor sensor battery installation

4.4.1 Sensor Placement

The best mounting location for the indoor sensor is in a location that never receives direct sunlight, not even through windows. Also, do not install in a location where a nearby radiant heat source (radiator, heaters, etc.) will affect it. Direct sunlight and radiant heat sources will result in inaccurate temperature readings.

The sensor is meant to provide indoor conditions for display on the console, but if you would rather have a second source for outdoor conditions instead, you can mount this unit outside. The unit is weatherproof, but besides heeding the placement instructions above, you should also attempt to mount the unit under cover (eave or awning or similar).

To mount or hang the unit on a wall or wood beam:

- Use a screw or nail to affix the remote sensor to the wall, as shown on the left side of Figure 19, or
- Hang the remote sensor using a string, as shown in right side of Figure 19

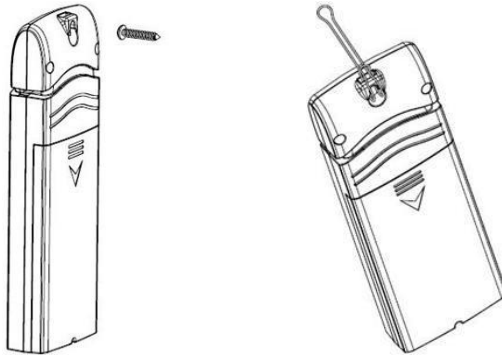

Figure 19: Indoor sensor mounting

Note: Make sure the sensor is mounted vertically and not lying down on a flat surface. This will insure optimum reception. Wireless signals are impacted by distance, interference (other weather stations, wireless phones, wireless routers, TVs and computer monitors), and transmission barriers, such as walls. In general, wireless signals will not penetrate solid metal and earth (down a hill, for example).

4.5 Outdoor Temperature and Humidity Sensor Operation

The operation for the outdoor temperature and humidity sensor is similar with the indoor sensor.

4.6 Best Practices for Wireless Communication

Wireless (RF) communication is susceptible to interference, distance, walls and metal barriers. We recommend the following best practices for trouble free wireless communication between both sensor packages and the console:

- **Indoor/outdoor sensor placement:** The sensor will have the longest reach for its signal when mounted or hung vertically. Avoid laying it down on a flat surface.
- **Electro-Magnetic Interference (EMI).** Keep the console several feet away from computer monitors and TVs.
- **Radio Frequency Interference (RFI).** If you have other devices operating on the same frequency band as your indoor and/or outdoor sensors and experience intermittent communication between sensor package and console, try turning off these other devices for troubleshooting purposes. You may need to relocate the transmitters or receivers to avoid the interference and establish reliable communication. The frequencies used by the sensors are one of (depending on your location): 433, 868, or 915 MHz (915 MHz for United States).
- **Line of Sight Rating.** This device is rated at 300 feet line of sight (under ideal circumstances; no interference, barriers or walls), but in most real-world scenarios, including a wall or two, you will be able to go about 100 feet.
- **Metal Barriers.** Radio frequency will not pass through metal barriers such as aluminum siding or metal wall framing. If you have such metal barriers and experience communication problems, you must change the placement of sensor package and or console.

The following table shows different transmission media and expected signal strength reductions. Each “wall” or obstruction decreases the transmission range by the factor shown below.

Medium	RF Signal Strength Reduction
Glass (untreated)	5-15%
Plastics	10-15%
Wood	10-40%
Brick	10-40%
Concrete	40-80%
Metal	90-100%

Table 4: RF Signal Strength reduction

4.7 Console Display

See 错误!未找到引用源。 to help you identify elements of the console's display screen.

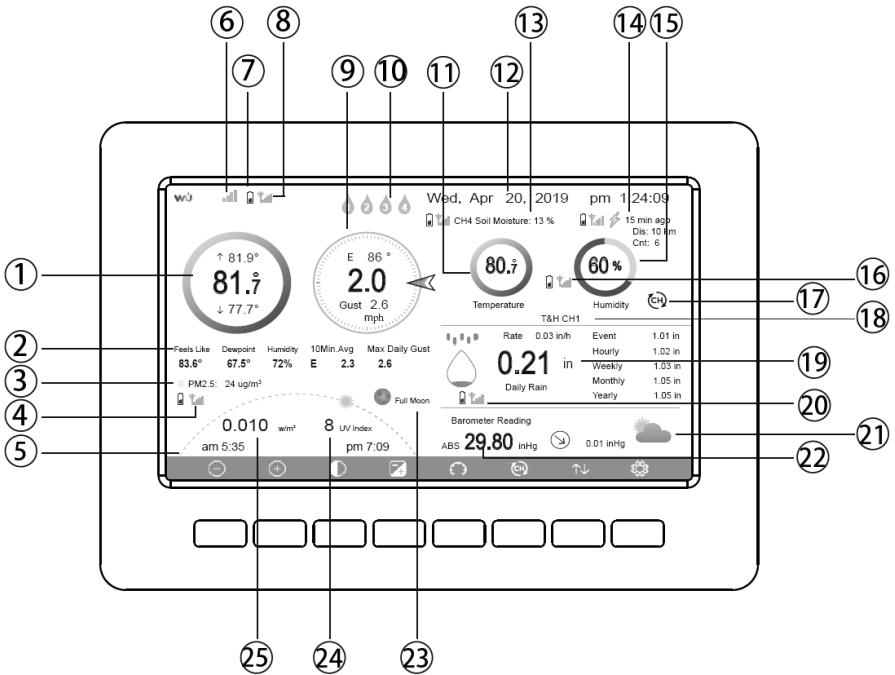

Figure 20: Display Console Screen Layout

No	Description	No	Description
1	Outdoor temperature	14	Last lightning strikes detected time / distance; daily counts (optional sensor)
2	Outdoor Feels Like/Dew point/Humidity/10Min. Average Wind Direction/Max Daily Gust	15	Indoor humidity
3	PM2.5 concentration display, WH41/WH43/WH45 particle detection sensor cycle display (optional sensor)	16	RF signal bar for multi-channel temperature and humidity sensor (optional sensor)

No	Description	No	Description
4	RF signal bar for PM2.5 sensor(optional sensor)	17	Multi-channel temperature and humidity sensor cycle display mode icon(optional sensor)
5	Sunrise / Sunset Time	18	Multi-channel temperature and humidity sensor channel number (optional sensor)
6	Wi-Fi signal bar	19	Rain fall Daily/Event/Hourly/Weekly/ Monthly/Yearly
7	Low battery power indicator for each sensor	20	RF signal bar for rain fall sensor
8	RF signal bar for outdoor sensor array	21	Weather forecast
9	Wind direction/Wind speed/Gust	22	ABS/REL Barometer
10	Multi-channel water leak sensor (optional)	23	Moon Phase
11	Indoor temperature	24	UV
12	Date and time	25	Solar Radiation
13	Soil moisture(optional sensor)		

Table: Display console detailed items

Note: If you have purchased the optional WH55 water leak sensor, please check the following instructions for the display color:

- Green - normal
- Red & Flash - leaking
- Yellow - low battery alert
- Orange - offline over 10 minutes

Initial Display Console Set Up

Immediately after power up (inserting power adapter), the unit will turn on the display, and the unit will start to look for reception of the indoor and outdoor sensor data. This may take up to 3 minutes.



Dark Background Display

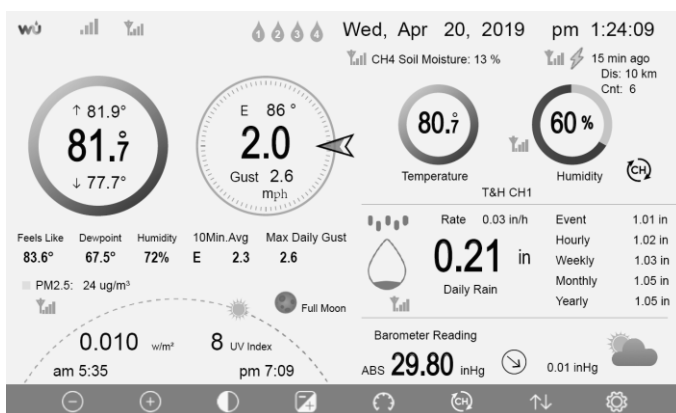

Light Background Display

Note: Sunrise/sunset time display will only work properly when GEO location has been set up correctly. GEO setup can be carried out under setup menu.

Key functions

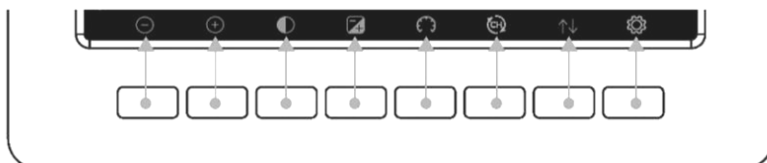

Figure: Buttons around the display

There is a set of eight keys on the bottom of the display console. The following tables briefly explains the function of these keys.





















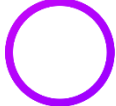

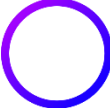
Icon	Description
	Brightness control key Press this key to decrease the brightness
	Brightness control key Press this key to enhance the brightness
	Backlight on/off key Press this key to on/off the backlight
	Background key Press this key to choose between dark background display and light background display
	Pressure display key Press this key to choose the display between Absolute pressure and Relative pressure.
	Channel key Press this key to Shift the display between indoor temp & humidity, Multiple Channel temp& humidity and scroll automatically mode
	History key Press this key once to view Max/Min record; Press twice to enter History mode; Press three times to enter Graph Mode; Press four times to enter optional Sensors Display Mode
	Setting key Press this key to enter Setting Mode

Table: Console buttons

Main interface icons explain



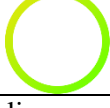







Temperature Icon

Temperature Range (degF)	Color Ring	Temperature Range (degF)	Color Ring
< -10		50-60	
-10 to 0		60-70	

0 to 10		70-80	
10-20		80-90	
20-30		90-100	
30-40		100-110	
40-50		> 110	

Note: please refer to the online manual for colorful display.

Humidity Icon

Humidity Range (%)	Color Ring	Humidity Range (%)	Color Ring
0%, No signal or dashes		50 to 60	
1 to 10		60 to 70	
10 to 20		70 to 80	
20 to 30		80 to 90	
30 to 40		90 to 99	





Current wind direction indication , 10-minute average wind direction indication .

Hourly Rainfall Icon

Hourly Rain (in)	Icon	Hourly Rain (in)	Color Ring
0.0		0.6 to 0.8	
0 to 0.2		0.8 to 1	
0.2 to 0.4		1 to 1.2	
0.4 to 0.6		1.2 to 1.4	

Multiple Channel Selection and Scroll Mode

The multi-channel sensor is an optional sensor, not included in the package. If you have multiple wireless sensors, while in normal mode, press the  key to toggle display in sequence of indoor, ch1, ch2...ch8, scroll display. Please note if only CH2 is received, it will skip CH1, and toggle only between indoor and already learned sensors.

While in Scroll display mode, the scroll icon  will be displayed next to the indoor humidity, and will scroll every 5 seconds.

Note: For all optional sensor(s), the history data will be saved to a microSD card(not included).

History Mode

View and Reset MAX/MIN



While in normal display, press the  key once to view and reset minimum and maximums.

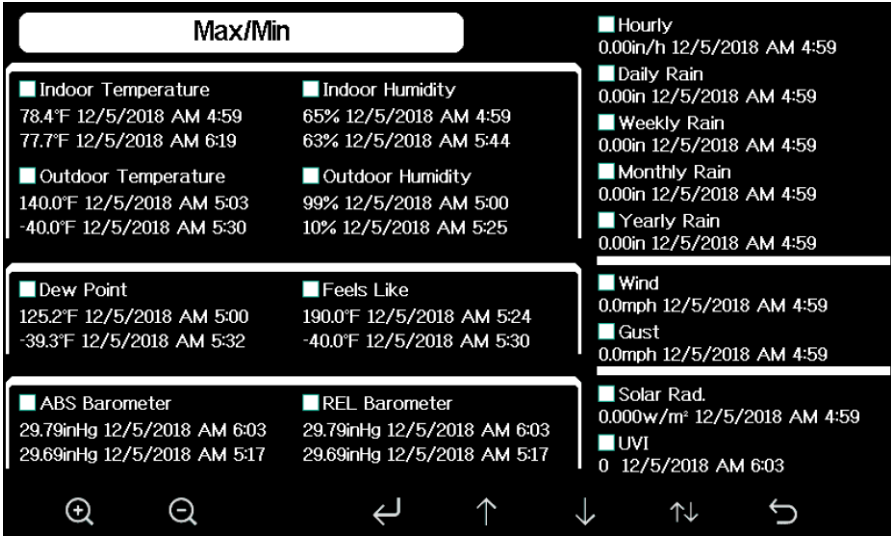













Figure: Max/Min Screen

Icon	Description
	Selection key Press this key to select the weather MAX/MIN record which need to clear
	Selection key Press this key to select the weather MAX/MIN record which need to clear
	Enter key While the desired weather MAX/MIN record selected , press this

	key to popup Message Box "Clear the Max/Min record?". Press  key or  key to select YES or NO. Press the  key or  key to confirm the selection.
	Up arrow key Press this key to change the activated option field
	Down arrow key Press this key to change the activated option field
	History key Press this key to select History data display.
	Return key Press this key to return to normal display mode

History Record Mode









While in normal display, press the  key twice to enter History Record Mode.



No	Time	Indoor Temperature (°F)	Indoor Humidity (%)	Outdoor Temperature (°F)	Outdoor Humidity (%)	Dew Point (°F)	Feels Like (°F)	Wind (mph)
2689	12/5/2018 AM 6:40	77.7	65	68.9	47	47.8	68.9	2.5
2690	12/5/2018 AM 6:45	77.7	65	68.9	47	47.8	68.9	2.5
2691	12/5/2018 AM 6:50	77.7	65	68.9	47	47.8	68.9	2.2
2692	12/5/2018 AM 2:40	77.9	65	68.9	47	47.8	68.9	2.5
2693	12/5/2018 AM 2:45	77.9	65	68.9	47	47.8	68.9	2.2
2694	12/5/2018 AM 2:50	77.9	65	68.9	47	47.8	68.9	2.2
2695	12/5/2018 AM 2:55	77.9	65	68.9	46	47.3	68.9	2.2
2696	12/5/2018 AM 3:00	77.9	65	68.9	46	47.3	68.9	2.2
2697	12/5/2018 AM 3:05	77.9	65	68.9	46	47.3	68.9	2.2
2698	12/5/2018 AM 3:10	77.9	65	68.9	46	47.3	68.9	2.2
2699	12/5/2018 AM 3:15	77.9	65	68.9	46	47.3	68.9	2.7
2700	12/5/2018 AM 3:20	77.9	64	68.9	46	47.3	68.9	2.5
2701	12/5/2018 AM 3:25	77.9	65	68.9	46	47.3	68.9	2.2
2702	12/5/2018 AM 3:30	78.1	65	68.9	46	47.3	68.9	2.2
2703	12/5/2018 AM 3:35	78.6	65	68.9	46	47.3	68.9	2.2
2704	12/5/2018 AM 3:40	78.6	65	68.9	46	47.3	68.9	2.2

Figure : History record Screen

Icon	Description
	File Select key Press this key to clear all history record

	Page Select key Press this key to enter particular page of the history data. Each page contains 16sets data.
	Scroll left key Press this key to view the left of the scrollable area.
	Scroll right key Press this key to view the right of the scrollable area.
	Page up key Press this key to scroll up the page you are viewing
	Page down key Press this key to scroll down the page you are viewing
	History key Press this key to select the Max/Min record or History.
	Return key Press this key to return to previous mode

While in History Record Mode, press  key to popup the Message Box: “Clear the history record?” Press “Yes” to clear all history records saved on console.

Press  or  key to return to History record Mode.

No	Time	Indoor Temperature (°F)	Indoor Humidity (%)	Outdoor Temperature (°F)	Outdoor Humidity (%)	Dew Point (°F)	Feels Like (°F)	Wind (mph)
2721	12/5/2018 AM 5:13	78.4	65	24.8	54	10.4	24.8	0.0
2722	12/5/2018 AM 5:18	78.4	65	59.0	73	50.4	59.0	0.0
2723	12/5/2018 AM 5:23	78.4	65	87.8	89	84.2	111.7	0.0
2724	12/5/2018 AM 5:28				19	69.8	123.8	0.0
2725	12/5/2018 AM 5:33				39	-39.3	-22.0	0.0
2726	12/5/2018 AM 5:38				58	0.1	12.2	0.0
2727	12/5/2018 AM 5:43				74	33.4	41.0	0.0
2728	12/5/2018 AM 5:48				95	77.2	78.8	0.0
2729	12/5/2018 AM 5:52				24	67.6	113.0	0.0
2730	12/5/2018 AM 5:57				42	--	-36.4	0.0

Figure : Clear History Record Screen



While in History Record Mode, press the  key to enter the page selection mode:









No	Time	Indoor Temperature (°F)	Indoor Humidity (%)	Outdoor Temperature (°F)	Outdoor Humidity (%)	Dew Point (°F)	Feels Like (°F)	Wind (mph)
2721	12/5/2018 AM 5:13	78.4	65	24.8	54	10.4	24.8	0.0
2722	12/5/2018 AM 5:18	78.4	65	59.0	73	50.4	59.0	0.0
2723	12/5/2018 AM 5:23	78.4	65	87.8	89	84.2	111.7	0.0
2724	12/5/2018 AM 5:28	78.4	65	123.8	19	69.8	123.8	0.0
2725	12/5/2018 AM 5:33				89	-39.3	-22.0	0.0
2726	12/5/2018 AM 5:38				58	0.1	12.2	0.0
2727	12/5/2018 AM 5:43				74	33.4	41.0	0.0
2728	12/5/2018 AM 5:48				95	77.2	78.8	0.0
2729	12/5/2018 AM 5:52				94	67.6	113.0	0.0
2730	12/5/2018 AM 5:57				42	--	-36.4	0.0
2731	12/5/2018 AM 6:24	77.4	64	-4.0	71	-11.2	-4.0	0.0

View data on page 1 to 171

00171

Ok Cancel

Figure : view a specific page of history Screen



Press  or  to select a digit in a number, press  or  key to change the number. Press  or  to change the activated option field, toggle OK or Cancel then press  or  key to confirm.

Graph Mode

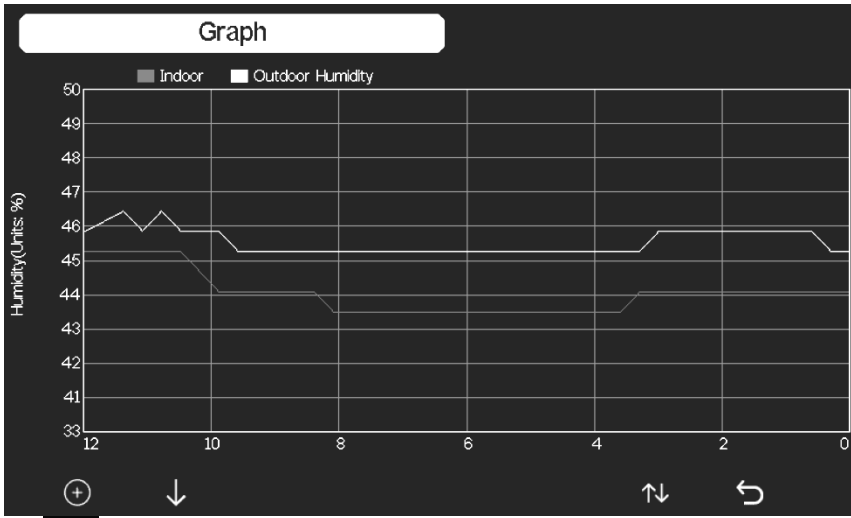

While in History Record Mode, press the  key once to enter Graph Mode.



Press  to shift the data display of 12/24/48/72H. Press  to view the graph of the following data:

- Indoor outdoor humidity
- Dew Point and Feels like
- Indoor outdoor temperature
- Wind speed and Gust
- Wind Direction
- UVI
- Solar radiation
- Rainfall hourly and daily
- Barometer(REL & ABS)

Optional Sensor Display Mode



To view the full display of multi-channel sensors you can do this:

While in Graph Mode, press the  key once to enter Optional Sensor Display Mode.

CH1 27.1°C 67%	CH2 27.2°C 67%	CH3 27.3°C 66%	CH4 27.3°C 66%	CH5 27.1°C 67%	CH6 27.4°C 67%	CH7 27.3°C 66%	CH8 27.3°C 66%
Soil CH1 0%	Soil CH2 0%	Soil CH3 0%	Soil CH4 0%	Soil CH5 0%	Soil CH6 0%	Soil CH7 0%	Soil CH8 32%
PM2.5 CH2 29ug/m³ Moderate AQI 24H 87 68	PM2.5 CH3 31ug/m³ Moderate AQI 24H 91 93	Water CH2 Normal	Water CH4 Normal	Lightning 20 min ago Dis Cnt 20km 5			

Note: Channel names can be edited on this page

Setting Mode

While in normal display, press the  key to enter Setting Mode. You can select the below sub-mode by pressing the  key

Setup

Date and Time Setup	Backlight Setup
Time Format <input style="width: 80%; border: 1px solid white; border-radius: 5px;" type="text" value="am h:mm:ss"/>	Longitude-Latitude Setup
Date Format <input style="width: 80%; border: 1px solid white; border-radius: 5px;" type="text" value="MM-DD-YYYY"/>	Week start at <input style="width: 80%; border: 1px solid white; border-radius: 5px;" type="text" value="Monday"/>
Temperature Units <input style="width: 80%; border: 1px solid white; border-radius: 5px;" type="text" value="°F"/>	Rainfall Season <input style="width: 80%; border: 1px solid white; border-radius: 5px;" type="text" value="January"/>
Barometer Units <input style="width: 80%; border: 1px solid white; border-radius: 5px;" type="text" value="inHg"/>	Interval <input style="width: 80%; border: 1px solid white; border-radius: 5px;" type="text" value="5 Minute"/>
Wind Speed Units <input style="width: 80%; border: 1px solid white; border-radius: 5px;" type="text" value="mph"/>	Weather Server Setup
Rainfall Units <input style="width: 80%; border: 1px solid white; border-radius: 5px;" type="text" value="in"/>	Wi-Fi Scan Setup
Solar Rad. Units <input style="width: 80%; border: 1px solid white; border-radius: 5px;" type="text" value="w/m²"/>	Background <input style="width: 80%; border: 1px solid white; border-radius: 5px;" type="text" value="Dark"/>
Multi Channel Sensor Setup	More Setup





















Figure : Setup Menu Screen

Icon	Description
	Select key Press this key to select the unit or scrolls the value
	Select key Press this key to select the unit or scrolls the value.
	Left key Press this key to select the set value.
	Right key Press this key to select the set value.
	Up arrow key Press this key to change the activated option field
	Down arrow key Press this key to change the activated option field
	Set key Press this key to select the Setting sub-Mode
	Return key Press this key to return to previous mode

Date and Time setting

While in Menu Setting Mode, press  key to select Date and Time Setup field, press  or  key to enter Date and Time Setup mode:

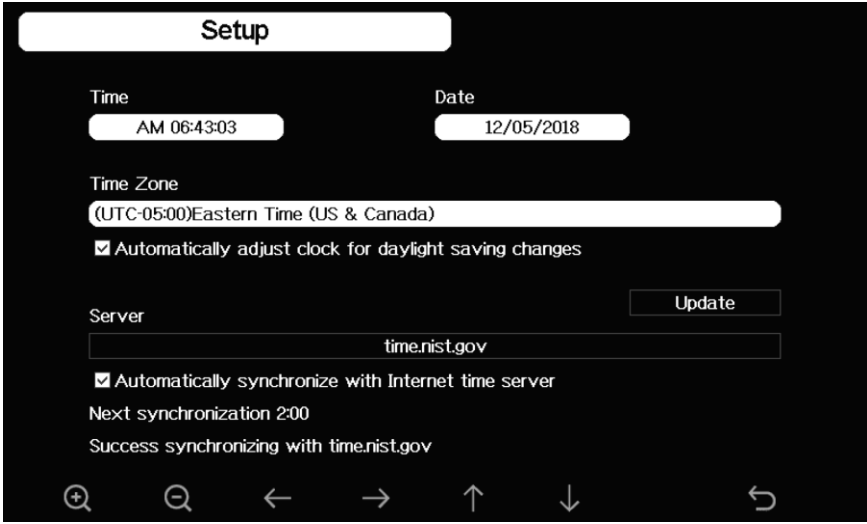

Figure : Time and date Setup Screen

1) Time setting (hour/minute/second)



Press key to select time setting field, and the hour digit will turn red, press the or key to change the hour setting. Press to set the minute, the minute digit will turn red, press the or key to change the minute setting. Press to set the second, and the second digit will turn red, press the or key to change the second setting

2) Date setting



Press key to select Date setting field, the day digit on focus turns red, press the or key to change the day setting. Press to set the month, then month digit focused will turn red, press the or key to change the month setting. Press to set the year, the year digit on focus will turn red, press the or key to change the year setting

3) Time zone setting

Press key to select Time zone setting field, press the or key to

change the time zone setting. Press  key to select Update field, press the  or  key to update the time immediately.

4) Automatically synchronize with internet time server

The time server is time.nist.gov. Press the  or  key to tick "Automatically synchronize with internet time server" and press "update" to synchronize with time server immediately. Console time will be updated at 2:01am automatically when internet access is possible.

Time Format setting

Press  to change the time format between hour: minute: second (h:mm:ss), hour: minute: second AM (h:mm:ss AM) and AM hour: minute: second (AM h:mm:ss).

Date Format setting

Press  to change the time format between DD-MM-YYYY, YYYY-MM-DD and MM-DD-YYYY

Temperature unit setting

Press  to change the temperature units of measure between °F and °C.

Barometric unit

Press  to change the temperature units of measure between inHg, mmHg and hPa

Wind speed unit

Press  to change the wind speed units of measure between mph, bft (Beaufort scale), ft/s, m/s, km/h and knot.

Rainfall unit

Press  to change the rainfall units of measure between in and mm

Solar Rad. Unit

Press  to change the solar radiation units of measure between W/m², lux and fc.

Multi Channel Sensor

In Multi channel sensor Setup Screen, you can rename the multi-channel temperature and humidity sensor or register the sensor again while the sensor lost connection to console display.

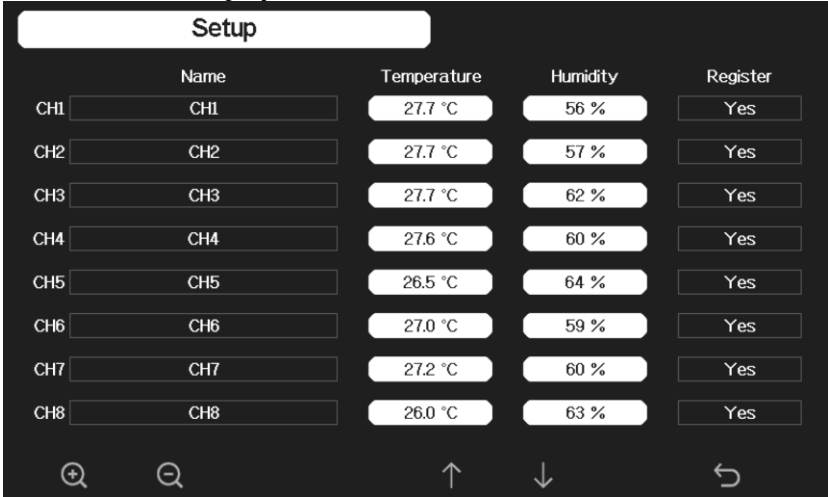











Figure : Multi channel sensor Setup Screen

Press  or  key to select Name setting field, the name on focus turns green, press the  or  key to pop up the keyboard to enter the sensor name. Press     to scroll to the character and press  to select the character. Press  to return to the setup page.

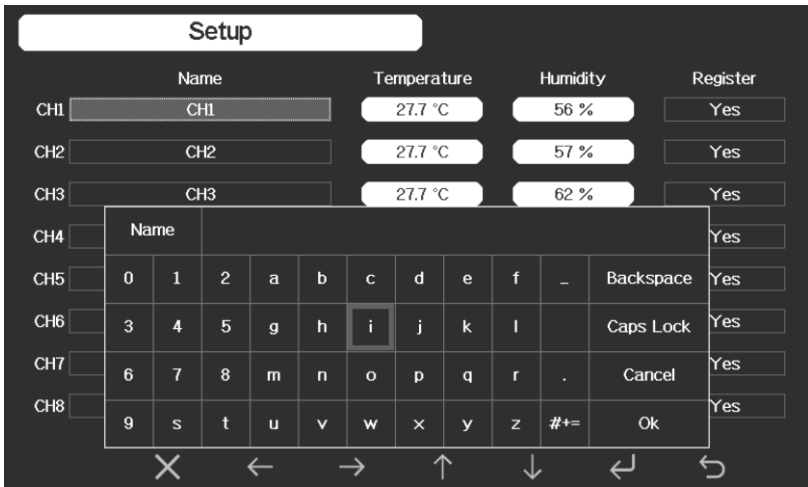



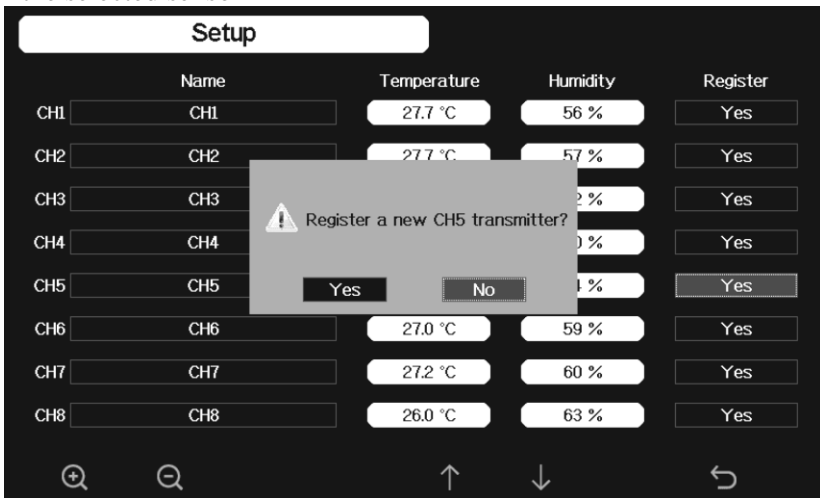





Figure : rename the sensor Screen

Press  or  key to select Register setting field, press the  or  key to register the selected sensor



Backlight setting

While in Menu Setting Mode, press  key to select Backlight Setup field, press  or  key to enter backlight Setup mode:

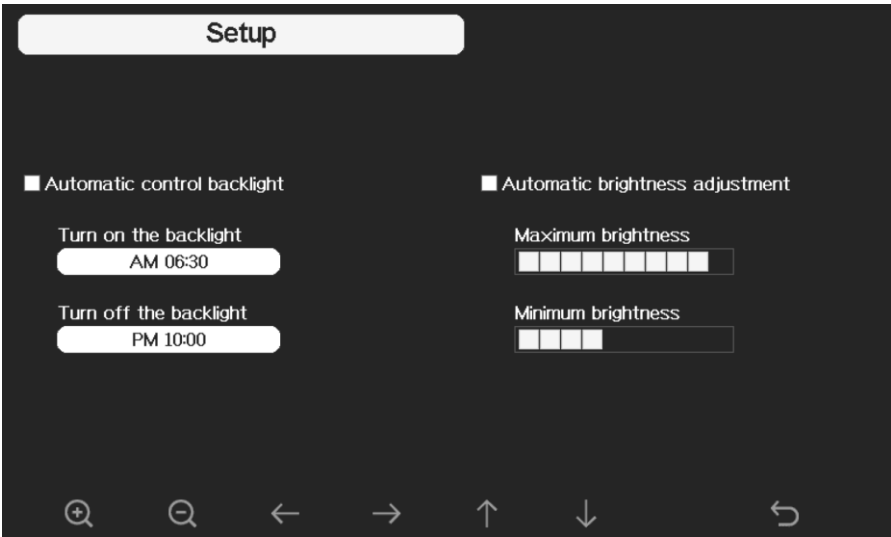

Figure : Backlight Setting Screen

Automatic control backlight: select this option, the backlight will auto turn on and off according the set time

Turn on the backlight: set the time of turning on backlight



Turn off the backlight: set the time of turning off backlight

Automatic brightness adjustment: select this option, the brightness will change according to the light intensity measured from outdoor sensor

Maximum brightness: set the maximum brightness while it is the highest light intensity

Minimum brightness: set the minimum brightness while it is the weakest light intensity

Icon	Description
	Select key Press this key to select the unit or scrolls the value
	Select key Press this key to select the unit or scrolls the value.
	Left key Press this key to select the set value.
	Right key Press this key to select the set value.
	Up arrow key Press this key to change the activated option field

	Down arrow key Press this key to change the activated option field
	Return key Press this key to return to previous mode

If the auto backlight turn-on time has been set, you can press  key to turn off the backlight within the turn on time. Backlight will turn on again automatically at next turn on time. You can press any key to turn on the backlight for 60s within the turn off time

Longitude: Latitude setting



While in Menu Setting Mode, press  key to select Longitude: Latitude Setup field, press  or  key to enter Longitude Latitude Setup mode:



Figure : Longitude and Latitude Setting Screen

The sunrise/sunset times will be calculating automatically base on the Longitude and Latitude. Your location GEO info can be found on mobile compass page. Two digits after decimal should be enough for this feature to be working correctly.

Week Start Set

Press  to set the week start at Sunday or Monday.

Rainfall season (default: January)



Press  to change the beginning of the rainfall yearly season month. The default is January. Rainfall season influence the annual rainfall maximum, minimum and total value. When one month was selected, the annual rainfall and annual max/min rainfall were zero clearing at 0:00 of the first day of the selected month.

Storing Interval (1-240minutes Selectable)

Weather Server

You may jump to section 4.9.16 now to have your console connected with your Wi-Fi network first. Then back to this section to have cloud data hosting setup completed.

Your console is capable of sending your sensor data to select internet-based weather services. The supported services are shown in the table below:

Service	Description
Weather Underground	Site: https://wunderground.com provides local & long-range weather forecasts, weather reports, maps & tropical weather conditions for locations worldwide.
WOW	Site: https://wow.metoffice.gov.uk A UK based weather observation website.
Weather Cloud	Site: https://weathercloud.net A large network of weather stations reporting data in real time from all over the world.
Ecowitt Weather	Site: https://www.ecowitt.net Ecowitt's new weather server that can host a bunch of sensors that other services don't support at this time.

Table: Supported weather services

Note: If you are testing the setup with the outdoor sensor package nearby and indoor, you may want to consider connecting to Wi-Fi, but not yet configuring any of the weather services. The reason is that while indoor the temperatures and humidity recorded by the outdoor sensor, and as reported to the weather service(s) will reflect indoor conditions, and not outdoor conditions. Therefore, they will be incorrect. Furthermore, the rainfall bucket may be tripped during handling, causing rain to register while it may not actually have been raining. One way to prevent this is to follow all instructions, except to use an incorrect password, on purpose!

Then, after final outdoor installation, come back and change the password after clearing console history. That will start uploading to the services with a clean slate.























Press  or  key to enter Weather Server set up mode. The device can be configured to send real-time data to wunderground.com®. Enter the Station ID and Password obtained from Wunderground.com.



Figure : Weather Server setup screen

				
scroll value up	scroll value down	Scroll field up	Scroll field down	return to Setup



- 1) **Set Station ID.** Press  to highlight the Station ID. Enter your station ID. Press  to display the keyboard. Press     to scroll to the character and press  to select the character. **Press the “OK” button to confirm.** Press  to return to the setup page.
- 2) **Set Station Key.** Press  to highlight the station key. Enter your password obtained from according weather server. Press  to display the keyboard. Press     to scroll to the character and press  to select the character. **Press the “OK” button to confirm.** Press  to return to the setup page.

Registering with and using wunderground.com

Perform the following steps to get the Station ID and Password on wunderground.com:

1. Visit Wunderground.com and select the **Join** link at the top of the page and sign up.

WEATHER UNDERGROUND | Sensor Network | Maps & Radar | Severe Weather | News & Blogs | Mobile Apps | More

Search Locations | Log In | Join

Popular Cities: San Francisco, CA (53°F Clear), Manhattan, NY (51°F Clear), Schiller Park, IL (60/176) (41°F Mostly Cloudy), Boston, MA (54°F Cloudy), Houston, TX (79°F Cloudy), London, England, United Kingdom (WC2H 7DE) (51°F Mostly Cloudy)

Member Account

Join Weather Underground

- Choose real-time alerts for your city.
- Choose adding your webcam or personal weather station.
- You can delete your account at any time from your member settings.

The Weather Company needs your email to create your Weather Underground account.

Email

Password (5-30 characters) [Show](#)

Confirm New Password:

I agree to the [Terms of Use](#)

[Sign up for free](#)

Already have an account? [Sign in](#)

1. Click My Profile and select My Devices to register your station

WEATHER UNDERGROUND | Sensor Network | Maps & Radar | Severe Weather | News & Blogs | Mobile Apps | More

Search Locations | **My Profile** | Settings

Popular Cities: San Francisco, CA (53°F Clear), Manhattan, NY (51°F Clear), Schiller Park, IL (60/176) (40°F Mostly Cloudy), Boston, MA (54°F Cloudy), Houston, TX (79°F Cloudy), London, England, United Kingdom (WC2H 7DE) (52°F Partly Cloudy)

Welcome back! | Member Settings | **My Devices** | Sign Out

San Francisco, CA

50°F | Feels like 47° | 48° | 4% / 0.00 in

12AM 49° 6AM 49° 9AM 59° 12PM 63° 3PM 62° 6PM 58° 9PM 51°

Full Forecast

2. Select Add New Device.

WEATHER UNDERGROUND | Sensor Network | Maps & Radar | Severe Weather | News & Blogs | Mobile Apps | More

Search Locations | My Profile | Settings

Popular Cities: San Francisco, CA (53°F Clear), Manhattan, NY (51°F Clear), Schiller Park, IL (60/176) (40°F Mostly Cloudy), Boston, MA (54°F Cloudy), Houston, TX (79°F Cloudy), London, England, United Kingdom (WC2H 7DE) (52°F Partly Cloudy)

Member Settings

EMAIL & PASSWORD | HOME & FAVORITES | **MY DEVICES** | API KEYS

Manage Devices

[Add New Device](#)

0 DEVICES TOTAL

No devices to show

Weather Underground is a global community of people connecting data from

3. Find Personal Weather Station. Select 'other' and click 'Next'.

Add a New Device

TYPE LOCATION DETAILS DONE

Select a Device Type

25%

Personal Weather Station

other

Cancel

- RainWise MK-III-LR
- RainWise AgroMET
- Raspberry Pi
- Texas Instruments WR-25-C
- Texas Instruments WLS-8000
- Texas Instruments WPS
- Texas Instruments WRS-Standard
- Texas Instruments WRS-Solar
- TML208
- Tycon Power Systems ProWeatherStation
- WeatherFlow
- WeatherHawk 611
- WeatherHawk 610
- WeatherHawk 620
- WeatherHawk 621
- WeatherHawk 232
- WeatherHawk 916
- WeatherHawk 922
- WeatherHawk 240
- other

Outdoor Webcam

Select camera type

Network Terms of Use
GetMap Privacy Policy
Help & Support AdChoices
Data Vendors

Technology for good. Take control of your data.
Data Rights
The IBM Cloud

WeatherWise
wu
© Technology LLC 2014, 2021

4. Select 'Address' or 'Manual' option, and find your local position. Press 'Next'.

Add a New PWS

TYPE LOCATION DETAILS DONE

Set Device Name & Location

50%

Device Location:

Address Manual

48.101,11.363

Your Location has been verified and added!

Elevation: 1841 ft.
Lat, Lon: 48.101, 11.363
Neighborhood: Krailling
Time Zone: Europe/Berlin



Mapbox © OpenStreetMap | Improve this map

5. This time you will be asked details about your weather station. Go ahead and fill out the form.

Add a New PWS

TYPE LOCATION **DETAILS** DONE

Tell Us More About Your Device



Name:(Required) **Surface Type:**

Elevation:(Required) **Associate Webcam:**

Device Hardware:(Required)

Height Above Ground:

You Make Our Forecasts More Accurate, We Respect Your Privacy

Contribute to the Weather Underground community by sharing some information about yourself and your sensor. We use this information to manage your account and to improve the experience from the Weather Underground community. We may also share certain data for commercial purposes, such as your sensor location.

[Learn more about how we take your privacy seriously](#)

(Required) I Accept I Deny

Email Preferences:

I would like to receive PWS notifications.

6. After completing the weather station, you will see station ID and key/password.

Add a New PWS

TYPE LOCATION DETAILS **DONE**

Registration Complete!



Congratulations! Your personal weather station is now registered with Weather Underground.

Enter the information below to your weather station software.

Your PWS

Station ID:

Station Key:



7. Take note of the station ID and key/password and enter it in the Weather Server:

















Figure 31: Weather Server setup screen

scroll value up	scroll value down	Scroll field up	Scroll field down	return to Setup



- 1) Set Station ID.** Press to highlight the Station ID. Enter your station

ID. Press  to display the keyboard. Press     to scroll to the character and press  to select the character. Press the “OK” button to confirm. Press  to return to the setup page.

2) **Set Station Key.** Press  to highlight the station key. Enter your password obtained from according weather server. Press  to display the keyboard. Press     to scroll to the character and press  to select the character. Press the “OK” button to confirm. Press  to return to the setup page.

8. Refresh the page, you may have to wait about a few minutes until the status becomes ‘Online’. Then you can click device name to view data.

Member Settings

EMAIL & PASSWORD HOME & FAVORITES **MY DEVICES** API KEYS

Manage Devices Add New Device

1 DEVICES TOTAL

Name	Location	Status	ID	Key	Type	Manage
HPZ251.1	Shenzhen (Nanshan District), CN	Online			PWS	Edit Delete Copy credentials

Items per page: 10 1 – 1 of 1

Viewing data on wunderground.com

The most basic way to observe your weather station’s data is by using the wunderground.com web site. You will use a URL like this one, where your station ID replaces the text “STATIONID”:

<http://www.wunderground.com/personal-weather-station/dashboard?ID=STATIONID>

It will show a page such as this, where you can look at today’s data and historical data as well:

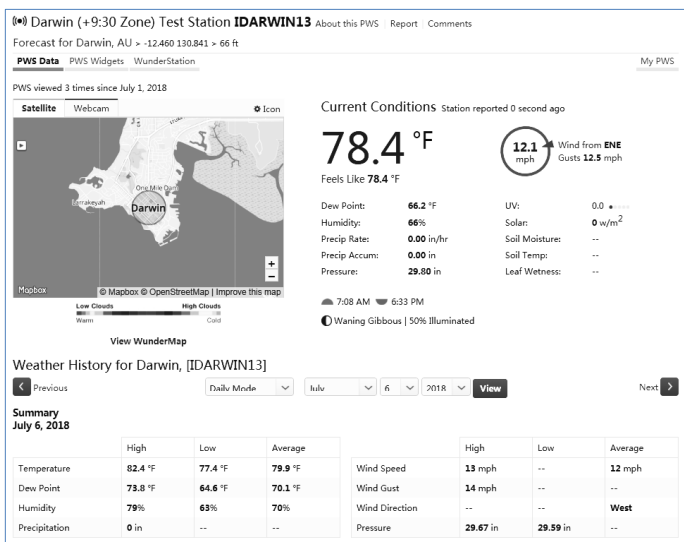

There are also some very useful mobile apps. The URLs provided here go to the Web version of the application pages. You can also find them directly from the iOS or Google Play stores:

- **WunderStation:** iPad application for viewing your station's data and graphs <https://itunes.apple.com/us/app/wunderstation-weather-from-your-neighborhood/id906099986>

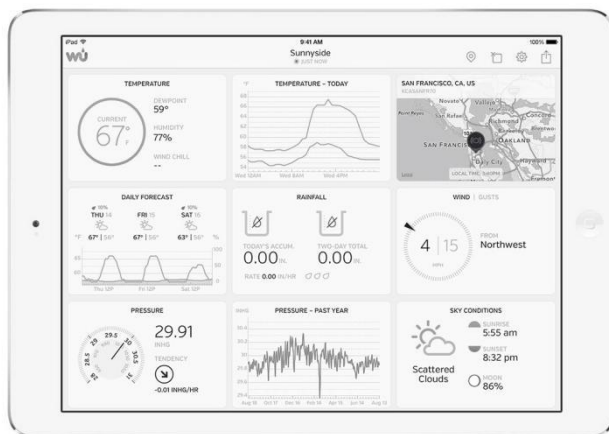

- **WU Storm:** iPad and iPhone application for viewing radar images, animated wind, cloud coverage and detailed forecast, and PWS station data <https://itunes.apple.com/us/app/wu-storm/id955957721>



- **Weather Underground: Forecast:** iOS and Android application for forecasts

<https://itunes.apple.com/us/app/weather-underground-forecast/id486154808>

<https://play.google.com/store/apps/details?id=com.wunderground.android.weather&hl=en>



PWS Weather Station Monitor: View weather conditions in your neighborhood, or even right in your own backyard. Connects to wunderground.com <https://itunes.apple.com/us/app/pws-weather-station-monitor/id713705929>

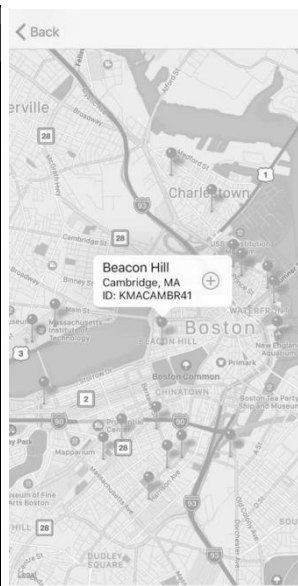
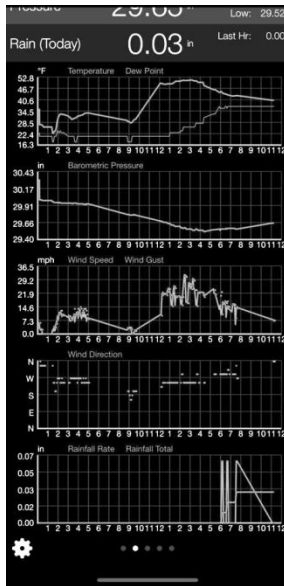

Registering with and using Ecowitt Weather

You can also use the Ecowitt Weather server to monitor and record all your sensors' data. Configure as follows:

- On the Weather Server page, set the reporting interval time (default: 1 minute).

- Visit the website: <https://www.ecowitt.net> on your computer and finish the registration on the page.
 - Press the upper left menu button and select Devices.
 - Press Add Device and input all the information needed(The MAC address can be found on the Weather Server page).
 - Press Save.
 - Press Dashboard on the menu. Your sensor data would be available on the dashboard within several minutes.

Note: When select device address on map, please wait until the map displays before selecting your address.

You may add a shortcut to the ecowitt.net website on the home page of your phone so that you can visit it just like opening an app.

Viewing data on ecowitt.net

You can observe your sensor's data by using the ecowitt.net web site. You will use a URL like this one, where your station ID replaces the text "STATIONID".

<https://www.ecowitt.net/home/index?id=STATIONID>

Note: If you want to share your station data with other users, you may use the Share option under the Menu to create a share link.

It will show a page such as this, where you can look at today's data and historical data as well.

Dashboard



Graph display

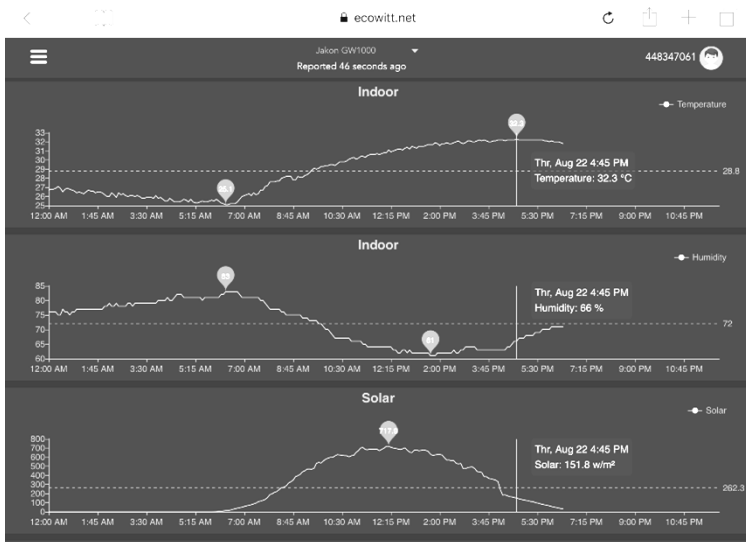

List display

ecowitt.net

Jakon GW1000
Reported 13 seconds ago

448347061

Daily

Aug/22/2019

Time	Temperature (°C)	Humidity(%)	Dew Point(°C)	Feels Like(°C)	Temperature (°C)	Humidity(%)	Absolute(hPa)	Relative(hPa)	Wind Speed(m/s)	Wind Gust(m/s)	Wind Dir
2019-08-22 18:30	31.3	77	26.8	40.9	31.8	72	997.8	997.8	1.0	2.0	41
2019-08-22 18:25	31.5	77	26.9	41.3	31.8	71	997.7	997.7	1.1	1.5	2
2019-08-22 18:20	31.5	76	26.8	41.2	31.9	71	997.8	997.8	0.8	1.5	3
2019-08-22 18:15	31.6	76	26.9	41.4	32.0	71	997.7	997.7	0.9	2.0	2
2019-08-22 18:10	31.7	75	26.8	41.5	32.0	71	997.6	997.6	0.7	2.0	3
2019-08-22 18:05	31.8	75	26.8	41.6	32.0	71	997.6	997.6	0.8	2.6	2
2019-08-22 18:00	31.9	74	26.7	41.6	32.1	71	997.5	997.5	1.1	3.1	8
2019-08-22 17:55	31.9	75	26.9	41.9	32.0	70	997.5	997.5	1.1	3.6	7
2019-08-22 17:50	32.1	74	26.9	42.4	32.1	70	997.4	997.4	1.0	2.0	5
2019-08-22 17:45	32.2	74	27.0	42.6	32.1	70	997.4	997.4	1.7	2.6	1
2019-08-22 17:40	32.3	74	27.1	42.9	32.2	70	997.1	997.1	0.6	2.0	2
2019-08-22 17:35	32.5	73	27.0	43.1	32.2	69	997.3	997.3	0.9	2.6	6
2019-08-22 17:30	32.7	72	27.1	43.6	32.2	69	997.4	997.4	0.5	1.5	5

Weather Map

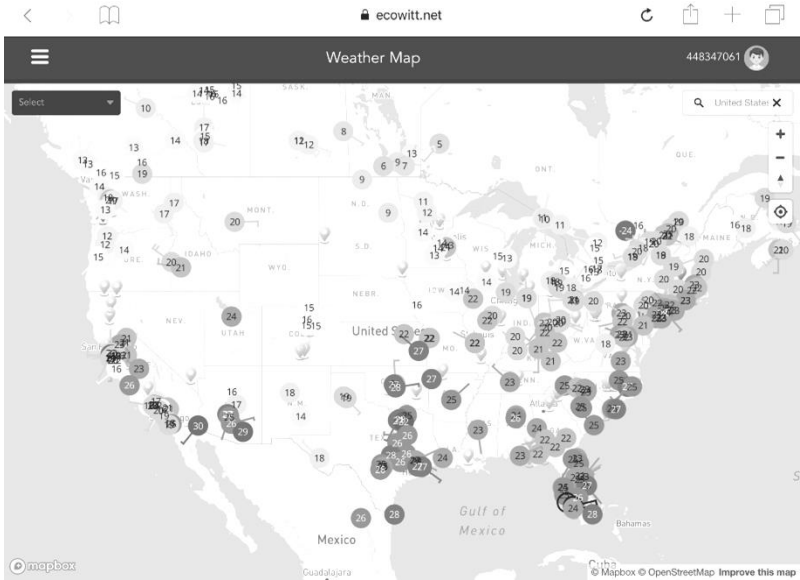

Email Alerts

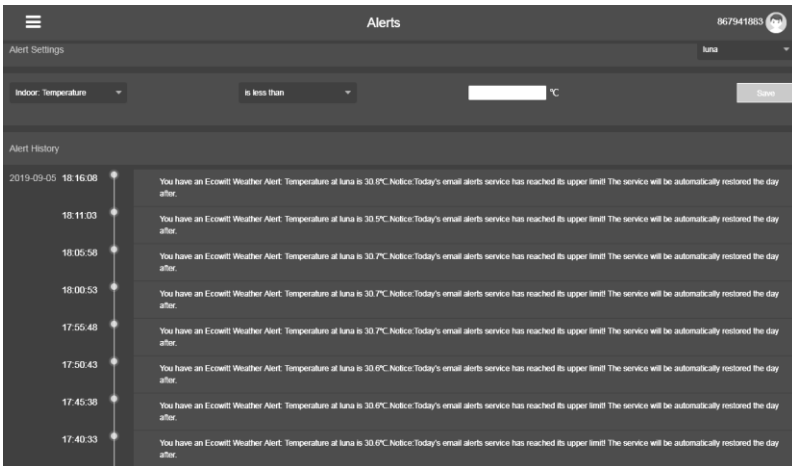

Customized server setup

For highly experienced users, it offers the option to send data to the user's own server. Press the "setup" button to enter Customized setup screen,



Figure : Server setup screen

Select Enable button and select the protocol type. The website should has the same protocol with Wunderground or Ecowitt. Input all the information needed.

Customized

State

Protocol Type

IP/Hostname

Port

Interval

Station ID

Station Key

⏏ ⏏ ⏪ ⏩ ⏴ ⏵ ↶

Customized

State

Protocol Type

IP/Hostname

Port

Interval

⏏ ⏏ ⏪ ⏩ ⏴ ⏵ ↶

Connect Console to Your Router: Wi-Fi scan

Entering this mode, system will display all the available Wi-Fi networks. Select the SSID that you want console to be connected with (only supports 2.4GHz band Wi-Fi network), and enter passer word as required.

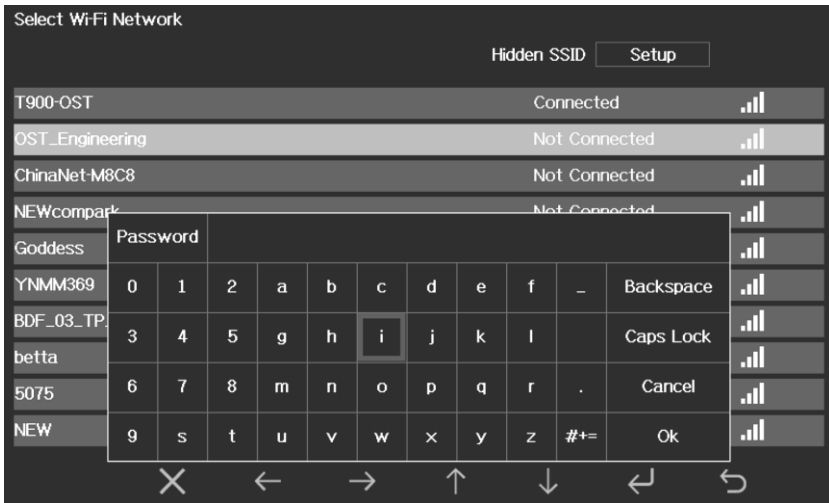

Press or key to select the Wi-Fi network. Press key to confirm and enter the password. Press key to return to normal display mode. It is possible

that your network is not listed when Wi-Fi Scan is performed. Press button and restart Wi-Fi Scan, this will usually solve the problem.

Only after connect to WLAN you can upload the data to weather website. If the Wi-Fi network connects successfully, the icon will show on the left top of the console display. If the data upload to Wunderground.com successfully, the icon will show on the left top of the console display.

If the Wi-Fi network you would like to connect is with a hidden SSID, please follow below steps to connect:



- 1) Press to select Hidden SSID setup, and press key directly to enter.
- 2) Press to highlight the SSID. Press to display the keyboard and enter your SSID. Press to scroll to the character and press to enter the character. Press to return to the setup page.
- 3) Press to highlight the Password. Press to display the keyboard and start to enter your password.. Press to scroll to the character and press to enter the character. Press to return to the setup

page.

4) Press  to highlight the “OK” button beside “Connect ” to start connecting. After connected successfully, the status will display” Connected”.



Background

While in Menu Setting Mode, press  key to select Background Setup field, press  or  key to choose between dark background display and light background display

Alarm Setting Mode

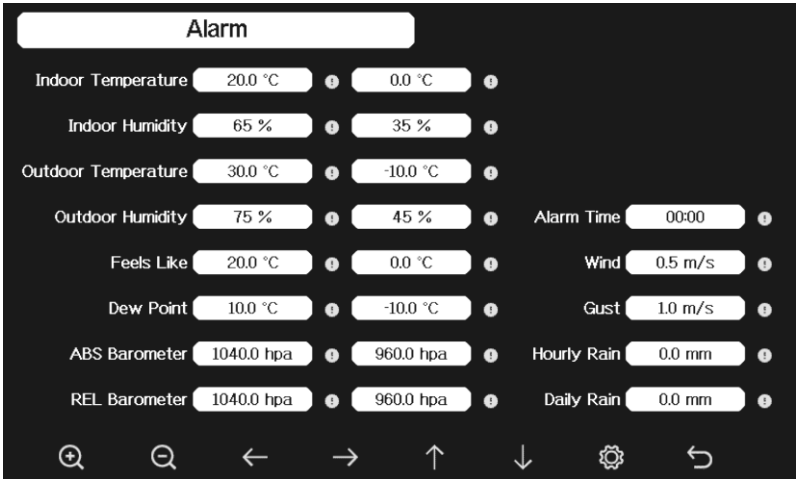

Icon	Description
	Select key Press this key to select the unit or scrolls the value
	Select key Press this key to select the unit or scrolls the value.
	Left key Press this key to select the set value.
	Right key Press this key to select the set value.
	Up arrow key Press this key to change the activated option field
	Down arrow key Press this key to change the activated option field
	Set key Press this key to select the Setting sub-Mode
	Return key Press this key to return to previous mode

The first row is high alarm value and the second row is low alarm value.

When weather alarm condition has been triggered, that particular alarm will sound for 120 second and the corresponding icon will flash until the weather condition doesn't meet the user set level. Press any key to mute the alarm.

Calibration Mode

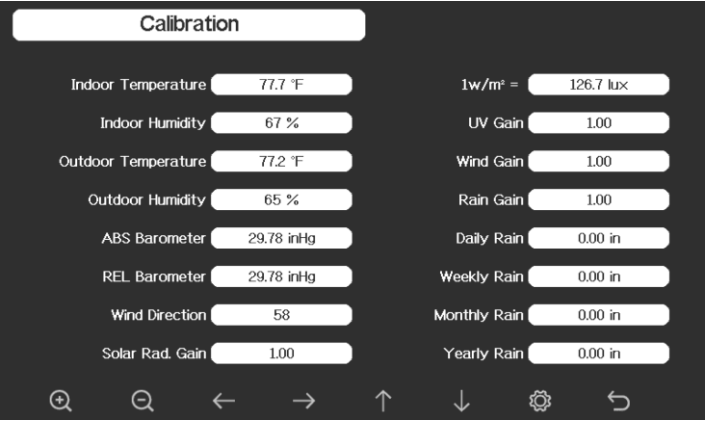

Icon	Description
	Select key Press this key to select the unit or scrolls the value
	Select key Press this key to select the unit or scrolls the value.
	Left key Press this key to select the set value.
	Right key Press this key to select the set value.
	Up arrow key Press this key to change the activated option field
	Down arrow key Press this key to change the activated option field
	Set key Press this key to select the Setting sub-Mode
	Return key Press this key to return to previous mode

To adjust the parameter, press to scroll to the parameter you wish to change. Press to highlight the sign (positive vs. negative, if applicable) and significant digit. Press or to change the calibrated value.

Parameter	Type of Calibration	Default	Typical Calibration Source
-----------	---------------------	---------	----------------------------

Temperature	Offset	Current Value	Red Spirit or Mercury Thermometer (1)
Humidity	Offset	Current Value	Sling Psychrometer (2)
ABS Barometer	Offset	Current Value	Calibrated laboratory grade barometer
REL Barometer	Offset	Current Value	Local airport (3)
Wind Direction	Offset	Current Value	GPS, Compass (4)
Solar Radiation	Gain	1.00	Calibrated laboratory grade solar radiation sensor
1 w/m ²	Gain	126.7 lux	Solar radiation conversion from lux to w/m ² for wavelength correction (5)
Wind	Gain	1.00	Calibrated laboratory grade wind meter (6)
Rain	Gain	1.00	Sight glass rain gauge with an aperture of at least 4" (7)
Daily Rain	Offset	Current Value	Apply an offset if the weather station was not operating for the entire day.
Weekly Rain	Offset	Current Value	Apply an offset if the weather station was not operating for the entire week.
Monthly Rain	Offset	Current Value	Apply an offset if the weather station was not operating for the entire month.
Yearly Rain	Offset	Current Value	Apply an offset if the weather station was not operating for the entire year.

(1) Temperature errors can occur when a sensor is placed too close to a heat source (such as a building structure, the ground or trees).

To calibrate temperature, we recommend a mercury or red spirit (fluid) thermometer. Bi-metal (dial) and digital thermometers (from other weather stations) are not a good source and have their own margin of error. Using a local weather station in your area is also a poor source due to changes in location, timing (airport weather stations are only updated once per hour) and possible calibration errors (many official weather stations are not properly installed and calibrated).

Place the sensor in a shaded, controlled environment next to the fluid thermometer, and allow the sensor to stabilize for 3 hours. Compare this temperature to the fluid thermometer and adjust the console to match the fluid thermometer.

- (2) Humidity is a difficult parameter to measure electronically and drifts over time due to contamination. In addition, location has an adverse affect on humidity readings (installation over dirt vs. lawn for example).

Official stations recalibrate or replace humidity sensors on a yearly basis. Due to manufacturing tolerances, the humidity is accurate to $\pm 5\%$. To improve this accuracy, the indoor and outdoor humidity can be calibrated using an accurate source, such as a sling psychrometer.

- (3) The display console displays two different pressures: absolute (measured) and relative (corrected to sea-level).

To compare pressure conditions from one location to another, meteorologists correct pressure to sea-level conditions. Because the air pressure decreases as you rise in altitude, the sea-level corrected pressure (the pressure your location would be at if located at sea-level) is generally higher than your measured pressure.

Thus, your absolute pressure may read 28.62 inHg (969 mb) at an altitude of 1000 feet (305 m), but the relative pressure is 30.00 inHg (1016 mb).

The standard sea-level pressure is 29.92 inHg (1013 mb). This is the average sea-level pressure around the world. Relative pressure measurements greater than 29.92 inHg (1013 mb) are considered high pressure and relative pressure measurements less than 29.92 inHg are considered low pressure.

To determine the relative pressure for your location, locate an official reporting station near you (the internet is the best source for real time barometer conditions, such as Weather.com or Wunderground.com), and set your weather station to match the official reporting station.

- (4) Only use this if you improperly installed the weather station sensor array, and did not point the direction reference to true north.
- (5) The default conversion factor based on the wavelength for bright sunlight is $126.7 \text{ lux} / \text{w/m}^2$. This variable can be adjusted by photovoltaic experts based on the light wavelength of interest, but for most weather station owners, is accurate for typical applications, such as calculating evapotranspiration and solar panel efficiency.
- (6) Wind speed is the most sensitive to installation constraints. The rule of thumb for properly installing a wind speed sensor is 4 x the distance of the tallest obstruction. For example, if your house is 20' tall and you mount

the sensor on a 5' pole:

Distance = $4 \times (20 - 5)' = 60'$ or $=4 \times (6.10-1.52)=18.32\text{m}$.

Many installations are not perfect and installing the weather station on a roof can be difficult. Thus, you can calibrate for this error with a wind speed multiplier.

In addition to the installation challenges, wind cup bearings (moving parts) wear over time.

Without a calibrated source, wind speed can be difficult to measure. We recommend using a calibrated wind meter (not included) and a constant speed, high speed fan.

- (7) The rain collector is calibrated at the factory based on the funnel diameter. The bucket tips every 0.01" or 0.1m of rain (referred to as resolution). The accumulated rainfall can be compared to a sight glass rain gauge with an aperture of at least 4" or 0.1m. Make sure you periodically clean the rain gauge funnel.

Note: The purpose of calibration is to fine tune or correct for any sensor error associated with the devices margin of error. Errors can occur due to electronic variation (example, the temperature sensor is a resistive thermal device or RTD, the humidity sensor is a capacitance device), mechanical variation, or degradation (wearing of moving parts, contamination of sensors).

Calibration is only useful if you have a known calibrated source you can compare it against, and is optional. This section discusses practices, procedures and sources for sensor calibration to reduce manufacturing and degradation errors. Do not compare your readings obtained from sources such as the internet, radio, television or newspapers. The purpose of your weather station is to measure conditions of your surroundings, which vary significantly from location to location.

Note: UV Calibration MUST be performed every 2 to 3 months to improve results. Over time, UV Index may alter results based on bright and strong sunlight conditions. This is why diligent UV Calibration is recommended.

More

On the More page, you can set the Calibration for the optional multi-channel soil moisture/PM2.5/temp and humidity sensor. You can also view or manage all the sensors ID on the Sensors ID Setup page.

More

Soil Moisture Calibration PM2.5 Calibration

Multi CH T&H Calibration Sensors ID

Calibration

Channel	Soil Moisture	Now AD	0%AD	100%AD	Customize	Reset
1	3%	83	<input type="text" value="70"/>	<input type="text" value="500"/>	<input type="text" value="OFF"/>	<input type="button" value="Reset"/>
2	62%	320	<input type="text" value="70"/>	<input type="text" value="500"/>	<input type="text" value="OFF"/>	<input type="button" value="Reset"/>
3	0%	26	<input type="text" value="70"/>	<input type="text" value="500"/>	<input type="text" value="OFF"/>	<input type="button" value="Reset"/>
4	51%	268	<input type="text" value="70"/>	<input type="text" value="500"/>	<input type="text" value="OFF"/>	<input type="button" value="Reset"/>
5	29%	188	<input type="text" value="70"/>	<input type="text" value="500"/>	<input type="text" value="OFF"/>	<input type="button" value="Reset"/>
6	0%	26	<input type="text" value="70"/>	<input type="text" value="500"/>	<input type="text" value="OFF"/>	<input type="button" value="Reset"/>
7	66%	335	<input type="text" value="70"/>	<input type="text" value="500"/>	<input type="text" value="OFF"/>	<input type="button" value="Reset"/>
8	63%	323	<input type="text" value="70"/>	<input type="text" value="500"/>	<input type="text" value="OFF"/>	<input type="button" value="Reset"/>

Calibration

Channel	PM2.5	PM2.5 Offset	Reset
1	34ug/m ³	<input type="text" value="0"/>	<input type="button" value="Reset"/>
2	35ug/m ³	<input type="text" value="0"/>	<input type="button" value="Reset"/>
3	42ug/m ³	<input type="text" value="0"/>	<input type="button" value="Reset"/>
4	--	<input type="text" value="0"/>	<input type="button" value="Reset"/>

Calibration					
Channel	Temperature	Humidity	Temp. Offset	Humi. Offset	Reset
1	--	--	0.0	0	Reset
2	82.2°F	45%	0.0	0	Reset
3	80.8°F	46%	0.0	0	Reset
4	81.0°F	47%	0.0	0	Reset
5	81.0°F	46%	0.0	0	Reset
6	81.3°F	47%	0.0	0	Reset
7	14.7°F	49%	0.0	0	Reset
8	81.3°F	45%	0.0	0	Reset

Note:

To calibrate the optional soil moisture sensor, please refer to the manual of the WH51 soil moisture sensor.

To calibrate the PM2.5 sensor, you'll need to find a reliable source, such as professional devices from your local air quality service.

To calibrate the temp and humidity sensor, please refer to section 4.9.19.

Sensor ID Setup

On this page you can set the following:

- View sensor ID, signal strength and battery power condition. 1-4 bars means 1-4 successful successive signal receptions without missed ones.
- Register the sensor when offline.
- Enable or disable the sensor.
- Input the Sensor ID when offline.

Sensor	Signal	ID	CH	Sensor	Signal	ID	CH	Sensor	Signal	ID
WH65		2f	1	PM2.5		3b	7	T&H		19
T&HP		49	2	PM2.5		c4ad	8	T&H		17
T&H		8a	3	PM2.5		5f	1	Soil		c4a7
WS80		60029	4	PM2.5		3f	2	Soil		c4c9
WH40		c49e	1	T&H		31	3	Soil		c4b3
WS68		334	2	T&H		81	4	Soil		c4ac
			3	T&H		65	5	Soil		c68f
			4	T&H		e5	6	Soil		-----
			5	T&H		66	7	Soil		10
			6	T&H		8e	8	Soil		c4bc

Sensor	Signal	ID	CH	Sensor	Signal	ID	CH	Sensor	Signal	ID
WH65		2f	1	PM2.5		3b	7	T&H		19
T&HP		49	2	PM2.5		c4ad	8	T&H		17
T&H		8a						Soil		c4a7
WS80		60029						Soil		c4c9
WH40		c49e						Soil		c4b3
WS68		334						Soil		c4ac
								Soil		c68f
								Soil		-----
			5	T&H		66	7	Soil		10
			6	T&H		8e	8	Soil		c4bc



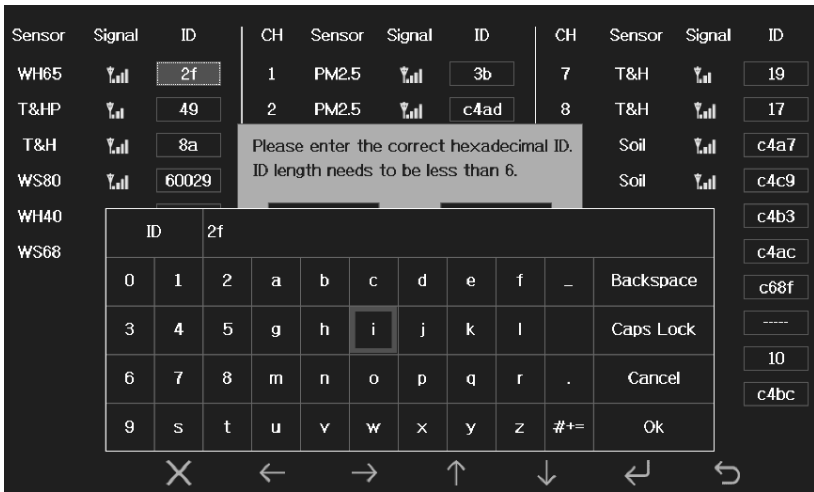



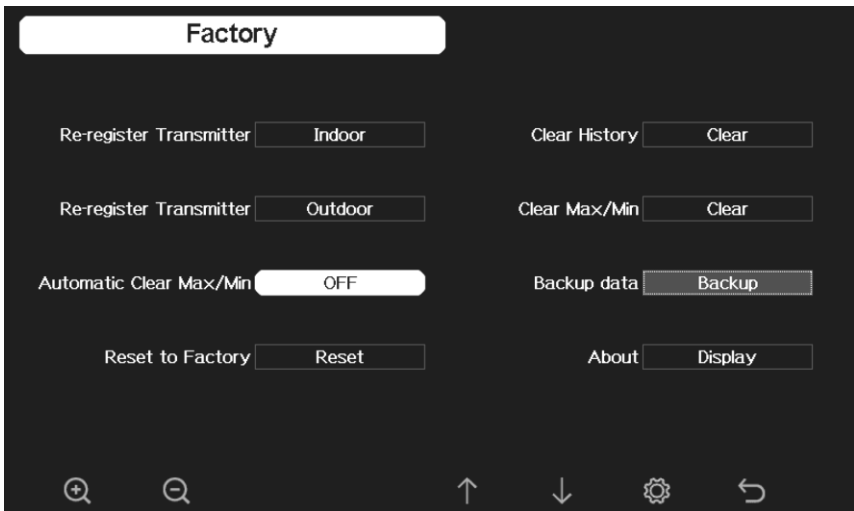

Please enter the correct hexadecimal ID.
ID length needs to be less than 6.



Factory reset







Re-register indoor transmitter

Press  or  key to select re-register indoor transmitter. Press  or  key to popup the Message Box "Register a new indoor transmitter?" Press  or  to select Yes or No. Press the  or  key to confirm the selection.

Re-register outdoor transmitter









Please reference section 5.13.1. Procedures and settings are similar to re-register indoor transmitter.

Automatic Clear Max/Min









To turn on/off automatically clear Max/Min record at 0:00hr every day. Press  or  key to select Automatic clear Max/Min. Press  or  key to switch on/off.

When it is selected with ON option, min/max will be presented as daily min/max, and with OFF option selected, it is for history min/max record.









Reset to Factory

Press  or  key to select Reset to Factory. Press  or  key to popup the Message Box "Reset to factory default?" Press  or  to select Yes or No. Press the  or  key to confirm the selection.









Clear History

Press  or  key to select Clear History. Press  or  key to popup the Message Box "Clear the history record?" Press  or  to select Yes or No. Press the  or  key to confirm the selection.

Clear Max/Min

Press  or  key to select Clear Max/Min. Press  or  key to popup the Message Box "Clear the max/min record?" Press  or  to select Yes or No. Press the  or  key to confirm the selection.

Backup data

Press  or  key to select Backup data. Press  or  key to popup the Message Box "Copy history data to SD card?" Press  or  to select OK or Cancel. Press the  or  key to confirm the selection.

Note: You need to insert a SD card(not included) into the console before using this function.

About information

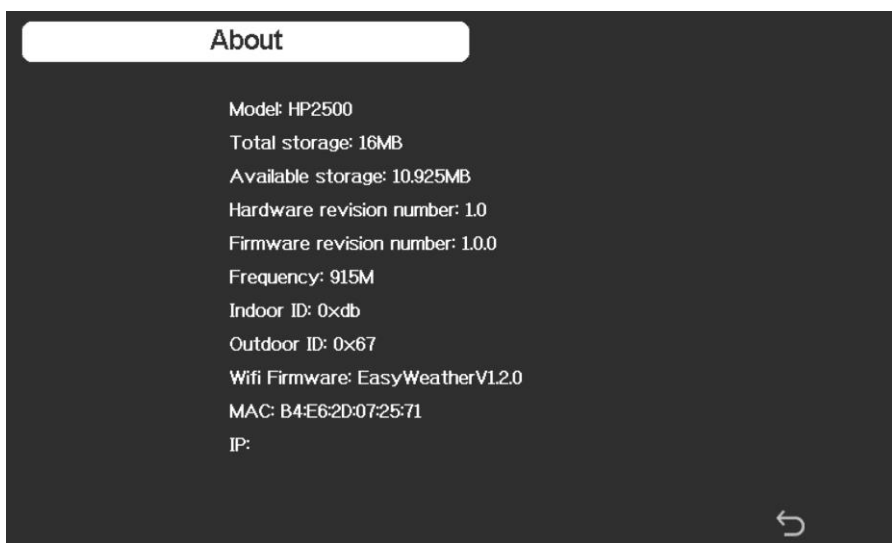

Note: This figure is just for reference(model and frequency will change according to different market). The actual display console may be with higher firmware version than this manual described because we will update the firmware occasionally.

Other Console Functions

Beaufort Wind Force Scale

If you have selected the use of Beaufort wind speed units, you can use the table below for reference. The Beaufort scale is based on qualitative wind conditions and how they would affect a ship's (frigate) sails (so yes, it is an "old" standard). It is therefore less precise than the other scales but is still in use in various locales.



Wind speed	Beaufort number	Description
0 - 1 mph, or 0 - 1.6 km/h	0	Calm
1 - 3 mph, or 1.6 - 4.8 km/h	1	Light air
3 - 7 mph, or 4.8 - 11.3 km/h	2	Light breeze
7 - 12 mph, or 11.3 - 19.3 km/h	3	Gentle breeze
12 - 18 mph, or 19.3 - 29.0 km/h	4	Moderate breeze
18 - 24 mph, or 29.0 - 38.6 km/h	5	Fresh breeze
24 - 31 mph, or 38.6 - 49.9 km/h	6	String breeze
31 - 38 mph, or 49.9 - 61.2 km/h	7	Near gale
38 - 46 mph, or 61.2 - 74.1 km/h	8	Gale
46 - 54 mph, or 74.1 - 86.9 km/h	9	Strong gale
55 - 63 mph, or 88.5 - 101.4 km/h	10	Storm
64 - 73 mph, or 103 - 117.5 km/h	11	Violent storm
74 mph and above, or 119.1 km/h and above	12	Hurricane





Table 1: Beaufort wind force scale

Weather Forecasting

The five weather icons are Sunny, Partly Cloudy, Cloudy, Rainy and Stormy, **Snowy and Storm Snowy**.

The forecast icon is based on the rate of change of barometric pressure. Please allow at least **one month** for the weather station to learn the barometric pressure over time.

Sunny	Partly Cloudy	Cloudy
		
Pressure increases for a sustained period of time	Pressure increases slightly or initial power up	Pressure decreases slightly
Rainy	Stormy	Snowy

		
Pressure decreases for a sustained period of time	Pressure rapidly decreases	Pressure decreases for a sustained period of time, and temperature $\leq 0^{\circ}\text{C}$
Storm Snowy		
		
Pressure rapidly decreases, and temperature $\leq 0^{\circ}\text{C}$		

Lightning Alert

The lightning icon  will appear if the Dew Point exceeds 70 F. This means there is a chance of lightning storms forming.

Weather Forecasting Description and Limitations

In general, if the rate of change of pressure increases, the weather is generally improving (sunny to partly cloudy). If the rate of change of pressure decreases, the weather is generally degrading (cloudy, rainy or stormy). If the rate of change is relatively steady, it will read partly cloudy.

The reason the current conditions do not match the forecast icon is because the forecast is a prediction 24-48 hours in advance. In most locations, this prediction is only 70% accurate and it is a good idea to consult the National Weather Service for more accurate weather forecasts. In some locations, this prediction may be less or more accurate. However, it is still an interesting educational tool for learning why the weather changes.



















The National Weather Service (and other weather services such as Accuweather and The Weather Channel) have many tools at their disposal to predict weather









conditions, including weather radar, weather models, and detailed mapping of ground conditions.

Moon Phase



In the event the moon phase is 100%, the icon  will appear in its place. In the event of 0%, the word “New Moon” will appear in its place.

Moon Phase	Image	Moon Phase	Image
Day 1		Day 14	
Day 2		Day 15	
Day 3		Day 16	
Day 4		Day 17	
Day 5		Day 18	
Day 6		Day 19	
Day 7		Day 20	
Day 8		Day 21	
Day 9		Day 22	

Day 10		Day 23	
Day 11		Day 24	
Day 12		Day 25	
Day 13 Full Moon		Day 26 New Moon	

5 Maintenance

The following steps should be taken for proper maintenance of your station

Clean Rain Gauge

Check the rain gauge every 3 months. Rotate the funnel counter-clockwise and lift it up. Clean the funnel and bucket with a damp cloth to remove any dirt, debris and insects. Spray the array lightly with insecticide, if there's a bug infestation.

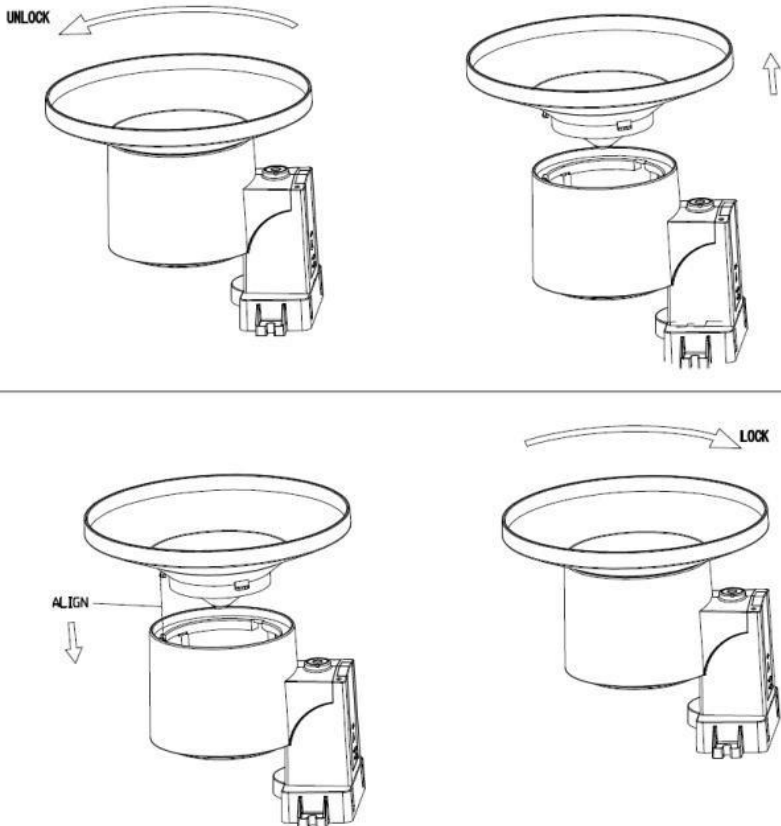

Figure: Rain gauge maintenance

Clean Solar Radiation Sensor and Solar Panel

The solar radiation sensor and solar panel of the outdoor sensor array need to be cleaned with a non-abrasive slightly damp cloth every 3 months.

Replacing Batteries Regularly

Batteries of the outdoor sensor array need to be replaced every 1-2 years for environmental friendly. In serious environments, check the batteries every 3 months and apply a corrosion preventing compound(not included) on the battery terminals for protection.

To Prevent Snow build up

In snowy days, use anti-icing silicon spray on the top of the weather station to prevent snow build up.

6 Troubleshooting Guide

Look through the following table and locate an issue or problem you are experiencing in the left column and read possible solutions in the right column.

Problem	Solution
<p>Outdoor sensor not reporting to console</p> <p>Dashes (--) on the display console</p>	<p>Check that the outdoor transmission LED is flashing normally. See Sensor reporting interval on Section 15.</p> <p>If the batteries were recently (re)placed, check correct polarity was used and/or reseal the batteries. If the batteries are old, replace them.</p> <p>If the LED is now flashing normally, proceed to the next step. If it is not flashing and you have repeated battery checks and placement, you may have a defective unit.</p> <p>Make sure you have fresh batteries in the display console.</p> <p>If the batteries may have been changed in the remote and/or the console, and the console has not been reset, the solution may be as simple as powering cycling the console: remove both batteries and external adapter for about 10 seconds and reconnect.</p> <p>If you still have problems, bring the outdoor sensor to a location about 10 ft. away from the console for testing. Power cycle the console as described above.</p> <p>Do not touch any buttons for several minutes to allow the console to “discover” the outdoor sensor. During this process the remote sensor search icon  will flash on the display. Wait several minutes for this icon to turn off.</p> <p>If the search icon turns off and the outdoor temperature and humidity are still showing dashes (--), the remote sensor is defective. If the sensor properly syncs up, proceed to the next step “Intermittent problems with outdoor sensor reception on console.”</p>

Problem	Solution
<p>Intermittent problems with outdoor sensor reception on console</p>	<p>There may be a temporary loss of communication due to signal quality issues caused by electrical interference or other location related factors (obstacles along line of sight).</p> <p>To troubleshoot, install a fresh set of batteries in the remote sensor and console. For cold weather environments, install lithium batteries.</p> <p>If problems remain with fresh batteries, ensure power adapter is not too close to the console, and the console is not close to other electrical noise generating devices such as TVs, monitors, computers and transmitting devices.</p> <p>If you still have intermittent problems move sensor and console closer together, but not closer than 5 ft. Also check that there are no metal barriers like aluminum siding, or metal wall framing, along the line of sight between sensor and console. Relocate sensor and console as necessary to avoid obstacles.</p> <p>Depending on natural barriers you may also have to move the outdoor sensor higher and/or closer.</p>
<p>Indoor temperature sensor reads too high in the day time, and/or night time</p>	<p>Make sure the thermo-hygrometer is mounted in an indoor area where it will not be exposed to direct sunlight, our radiative heating, or convective heating.</p>
<p>Indoor and Outdoor Temperature do not agree during indoor testing</p>	<p>During installation testing it is useful to test with both console and outdoor unit in the same room. Allow up to one hour for the sensors to stabilize and adjust to room temperature. The indoor and outdoor temperature sensors should agree within 4 °F (the sensor accuracy is ± 2 °F). If these values still disagree, use calibration offsets for one or both sensors (see section 5.3.1) to adjust to a known good reference temperature.</p>

Problem	Solution
Indoor and Outdoor Humidity do not agree during indoor testing	<p>The procedure here is that same as for outdoor/indoor temperature. The sensors should agree within 10 % (the sensor accuracy is $\pm 5\%$)</p> <p>If these values still disagree, use calibration offsets for one or both sensors (see section 5.3) to adjust to a known good reference humidity.</p>
Relative pressure does not agree with official reporting station	<p>Relative pressure refers to sea-level equivalent temperature and should generally agree closely with the official station. If there is a disagreement, make sure you are not looking at absolute pressure, in particular if your station is not near sea level. Also check at different times due to occasional delays in updates to the official station. Redo the pressure calibration procedure described in section 5.3.1.</p> <p>The barometer is only accurate to ± 0.09 inHg (3 hPa) within the following relative pressure range: 20.67 to 32.50 inHg (700 – 1,100 hPa), which corresponds to an altitude of 9,000 ft. (2,750 m) down to 2,500 ft. (750 m) below sea level. At higher altitudes, you should expect a possible lesser accuracy and non-linearity effects in the error (the calibration offset only allows for a partially linear correction).</p>
Time is incorrect	<p>Make sure your time zone and daylight savings time setting is correct (even when connected to the Internet via Wi-Fi this is needed). If not connected to the Internet via Wi-Fi, you may also have to manually set the correct time.</p>
Display console brightness is weak	<p>Adjust brightness using setup functions, or place console in a darker location.</p>

Problem	Solution
<p>Data not reporting to Wunderground.com</p>	<p>Confirm your station ID is correct. The station ID is all caps, and the most common issue is substituting a capital letter O for a 0 (zero) or vice versa. Please note the digit 0 can only occur in the last part of the station ID (which is a station number in a city). Example, KAZPHOEN11, not KAZPHOEN11</p> <p>Confirm that your password (also called: key) is correct. It is the password wunderground.com generated for your station ID. You can also verify it by logging in to wunderground.com and looking it up under “My PWS.” Make sure the date, time and time zone is correct on the console. If it is not incorrect, you may be reporting data for a point in the past or future and you may not see it where you expect it.</p> <p>Check your router firewall settings. The console sends data via port 80. If you can access other web sites using “http” (not to be confused with “https”) this setting will be OK.</p>
<p>No Wi-Fi connection</p>	<p>Check for Wi-Fi symbol on the display. If wireless connectivity is operational, the Wi-Fi icon  will be displayed in the time segment on the console.</p> <p>If the symbol is not displayed, but you do remember configuring it successfully before, check that the console external power adapter is plugged in and functional. Wi-Fi use demand more energy than batteries alone can provide.</p> <p>If you have never been able to configure Wi-Fi to a working state, make sure your Wi-Fi supports 2.4 GHz signals (801 type B or G, or N). The console does not support Wi-Fi that uses the 5 GHz spectrum.</p> <p>Make sure you configured the correct SSID and password. Repeat the procedure if necessary to verify.</p> <p>The console does not support so-called “captive Wi-Fi” networks. These are typically “guest” type networks where users have to agree to terms and conditions before being connected.</p>

7 Glossary of Common Terms

TERM	DESCRIPTION
ABSOLUTE AIR PRESSURE ABSOLUTE BAROMETRIC PRESSURE	Absolute air pressure is the air pressure registered on a barometer without regard to altitude.
BAROMETER	A barometer is a device that measures the pressure of the air pushing on it—this measurement is called the barometric pressure. We don't actually feel the barometric pressure because the air pressure is pushing equally in every direction.
BEAUFORT (Bft)	An indicator of wind force strength (not speed) as it would act on a ship's sails. Still commonly in used in some locales to indicate wind force.
DEW POINT	The temperature to which air must be cooled to become saturated with water vapor. When further cooled, the airborne water vapor will condense to form liquid water (dew), or frost if below freezing.
HEAT INDEX	The heat index (HI) or humiture is an index that combines air temperature and relative humidity, in shaded areas, as an attempt to determine the human-perceived equivalent temperature, as how hot it would feel if the humidity were some other value in the shade.
HECTOPASCALS (hPa)	This is an international standard (SI system) for measuring air pressure. It used to be referred to as milli-bar (mb) and sometimes still is. They are equivalent.

TERM	DESCRIPTION
HYGROMETER	An instrument that measure relative humidity of the air. This is expressed as a percentage between 0% and 100%.
INCHES OF MERCURY (inHg)	This is the common unit of measurement for air pressure in the United States. It refers to the length of a standard column of mercury (a liquid metal) that can be pushed up by the ambient air pressure. Standard pressure is approximately 29.92 inHg
KNOTS (kn)	One knot is equivalent to one nautical mile and is sometimes used to indicate wind speed.
LCD	An acronym for “Liquid Crystal Display.” This is a common type of display screen used in televisions, computers, watches, and digital clocks.
LUX (lx)	The unit of illuminance (a measure of the intensity of illumination on a surface) as used in the SI system.
MILLIBAR (mb)	See HECTOPASCALS.
MM OF MERCURY (mmHg)	This is similar to inches of mercury, except expressed in millimeters. Standard pressure is approximately 760 mmHg.
NIST	National Institute of Standards and Technology. A United States institute that keeps very accurate time using atomic clocks and provides an internet-based service to accurately set device clocks.
RELATIVE AIR PRESSURE RELATIVE BAROMETRIC PRESSURE	Relative air pressure is the absolute air pressure compensated for the altitude of the barometer. The result is what the air pressure would be at sea level.

TERM	DESCRIPTION
TFT	Thin-Film-Transistor, a type of LCD screen.
ULTRA VIOLET INDEX	The ultraviolet index or UV-Index (UVI) is an international standard measurement of the strength of sunburn-producing ultraviolet (UV) radiation at a particular place and time. The purpose of the UV Index is to help people effectively protect themselves from UV radiation. The UV Index is a linear scale, with higher values representing a greater risk of sunburn (which is correlated with other health risks) due to UV exposure. An index of 0 corresponds to zero UV radiation, as is essentially the case at night. An index of 10 corresponds roughly to midday summer sunlight with a clear sky when the UV Index was originally designed, but values above 10 are sometimes possible. Levels above 8 are considered “very high” and above 11 are considered “extreme.”
WIND CHILL	Wind chill (popularly wind chill factor) is the lowering of body temperature due to the passing-flow of lower-temperature air. In other words, the air “feels” colder than it is because of the chilling effect of the wind on the skin.

Table 9: Glossary of terms

8 Specifications

Note: Out of range values will be displayed using “---”:

Outdoor sensor	Specification
Transmission distance in open field	100 m (330 ft.)
RF Frequency	433/ 868/ 915MHz depending on location (North American: 915MHz; Europe: 868MHz; Other areas: 433MHz)
Temperature range	-40°C – 60°C (-40°F - 140°F)
Temperature accuracy	± 1°C, or ± 2°F
Temperature resolution	0.1°C, or 0.1°F
Humidity range	10% ~ 99%
Humidity accuracy	± 5%
Humidity resolution	1%
Rain volume display range	0 – 6000 mm
Rain volume accuracy	± 5%
Rain volume resolution	0.1mm/0.01inch
Wind speed range	0 – 50 m/s (0 ~ 100 mph)
Wind speed accuracy	± 1 m/s (speed < 5 m/s) ± 10% (speed ≥ 5 m/s), or ± 0.1 mph (speed < 11 mph) ± 10% (speed ≥ 11 mph)
UV-Index range	0 - 15
Light range	0 – 120 kLux
Light accuracy	± 15%
Sensor reporting interval	Anemometer: 16.5s; rain gauge sensor: 49s; thermo-hygrometer sensor: 64s

Table 10: Outdoor sensor specification

Indoor sensor	Specification
Temperature range	-10°C – 60°C (14°F - 140°F)
Temperature resolution	0.1°C, or 0.1°F
Humidity range	10% ~ 99%
Humidity resolution	1%
Barometric pressure range	300 – 1,100 hPa (8.85 – 32.5 inHg)
Barometric pressure accuracy	± 3 hPa in 700 – 1,100 hPa range
Barometric pressure resolution	0.1 hPa (0.01 inHg)
Sensor reporting interval	60s
Alarm Duration	120s

Table 11: Indoor sensor specification

Power	Specification
Base station/console	5V DC Adapter (included)
Indoor sensor	2 x AA 1.5 Alkaline batteries (not included)
Rain gauge sensor	1 x AA 1.5V LR6 Alkaline (not included), or 1 x AA 1.5V Lithium battery (not included)
Anemometer sensor	Solar panel (built-in): 6.5V/4mA
Anemometer sensor (backup)	2 x AA 1.5V Lithium battery (not included)
Power	Specification

Table 12: Power specification

The primary power source for the anemometer sensor is the solar panel. When available solar power (light over recent period) is insufficient, the battery will be used. In outdoor climates that frequently have sustained temperatures below 0°C (or 32°F) the use of Lithium batteries is strongly suggested as these are performing better than Alkaline batteries under such circumstances.

9 Warranty Information

We disclaim any responsibility for any technical error or printing error, or the consequences thereof.

All trademarks and patents are recognized.

We provide a 1-year limited warranty on this product against manufacturing defects, or defects in materials and workmanship.

This limited warranty begins on the original date of purchase, is valid only on products purchased, and only to the original purchaser of this product. To receive warranty service, the purchaser must contact us for problem determination and service procedures.

This limited warranty covers only actual defects within the product itself and does not cover the cost of installation or removal from a fixed installation, normal set-up or adjustments, or claims based on misrepresentation by the seller, or performance variations resulting from installation-related circumstances.